

Useful
Accessories

'Minicard',
Record
Cards

from—
A.S.W.P.
57 Maida Vale
Paddington
LONDON, W9.

GSO RECORD CARDS 2½ ins. x 2¼ ins. printed both sides, available or Amateur Station records, at 3/3 per 100 post paid. Metal filing trays as shown, heavy gauge steel, green enamel to hold 500 cards, 3/3 post paid. Indices not available.

THE MODERN BOOK CO.

The De Luxe Home-built Televisor and Radiogram. By W. I. Flack. 6s. 6d. Postage 4d.
Reference Data for Radio Engineers. Edited by W. L. McPherson. 7s. Postage 6d.
Amplifiers. By N. H. Crowhurst. 3s. 6d. Postage 3d.
Resistance Strain Gauges. By J. Yarnell. 12s 6d. Postage 6d.
Handbook of Line Communication. Vol. 1. The Royal Signals. 20s. Postage 1s.
Theory and Design of Valve Oscillators, Vol. 7. By H. A. Thomas. 2nd rev. edn. 36s. Postage 9d.
The Radio Amateur's Handbook. By The American Radio Relay League. 28th edn. 22s. 6d. Postage 1s.

We have the finest selection of British and American radio books in the Country.

19-23 PRAED STREET, (DEPT.) LONDON, W.2

PADDINGTON 4185.

Theory and Design of Television Receivers. By S. Deutsch. 55s. 6d. Postage 9d.
Telecommunications Principles. By R. N. Renton. 37s. 6d. Postage 9d.
Time Bases (Scanning Generators). By O. S. Puckle. 2nd rev. edn. 50s. Postage 9d.
Television Receiving Equipment. By W. T. Cocking. 3rd edition. 18s. Postage 6d.
Radio Servicing: Theory and Practice. By A. Marcus. 35s. Postage 9d.
Radio Valve Data. Compiled by "Wireless World." 2nd edn. 3s. 6d. Postage 4d.
Radio Installations. By W. E. Pannett. 45s. Postage 9d.

British and American radio Complete list on application.

Published by Amalgamated Short Wave Press Ltd., 57, Maida Vale, Paddington, London W.9 and Printed by A. Quick and Co. Ltd., Jackson Road, Clacton-on-Sea.

RADIO CONSTRUCTOR

for the Radio and Television Enthusiast

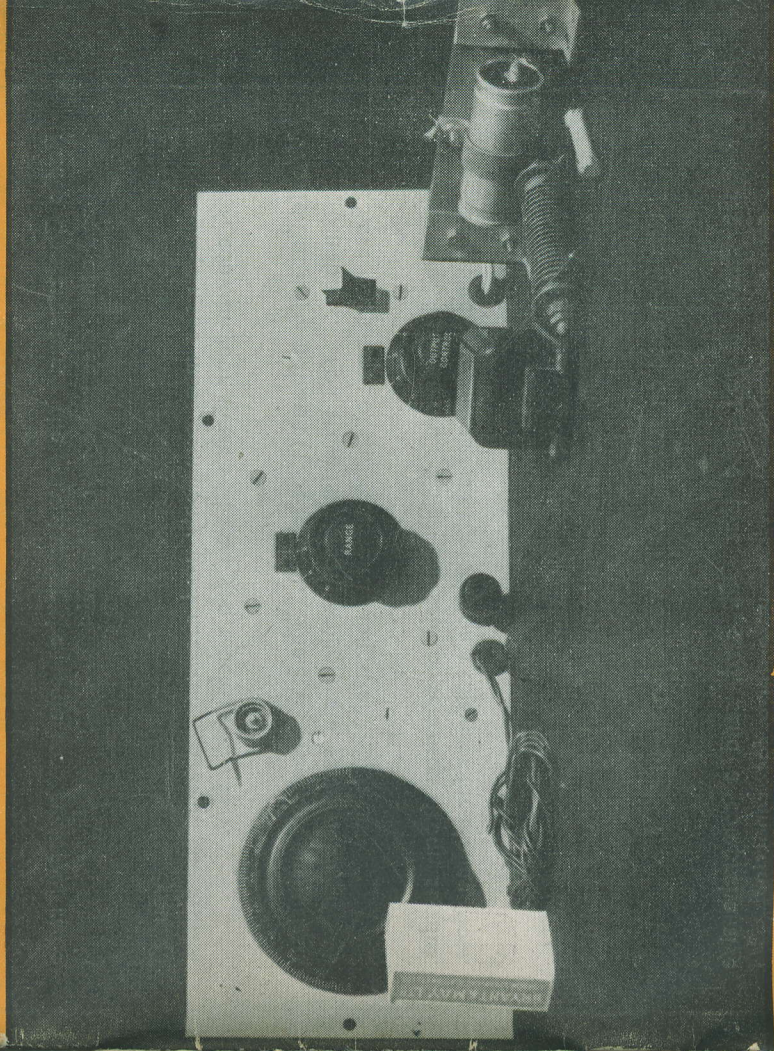

IN THIS ISSUE . . .

Single Valve Signal Generator · "1143" Modified for
2 Metres · A Transatron Inductance Meter · Radio
Control of Models · Converting the 21 Receiver—Cont.
Query Corner · Harmonic Drive · Your Workshop
etc., etc.

16

LITERATURE FOR THE RADIO AMATEUR

Short Wave News & Radio Amateur. Constructional articles, topical features and news reviews for the radio amateur whether his interest be receiving or transmitting. Annual Sub. 21/-

Radio Constructor. The magazine for the home constructor of radio and other electronic gear. Annual Sub. 18/-

World Radio Valve Handbook. A reference book giving you all data on the most commonly used receiving valves in the world. A copy in your shack will save you much time. 11/9.

World Radio Handbook (1952 edition). The S.W. broadcast enthusiasts handbook. You are missing something from your hobby if you have not a copy of this excellent publication. 8/9.

Inexpensive Television. Build yourself a television from surplus. Latest edition includes all the data on a television for Holme Moss. 2/8.

How to Listen to the World. Another useful little booklet by the publishers of the world famous World Radio Handbook and the World Radio Valve Handbook. Gives the beginner all the information he needs on starting S.W. broadcast listening. 1/8.

Report Pads. If you need that QSL card, send a comprehensive report. A convenient and accurate form for reporting. 3/3

All above prices include postage and packing.

All available from:—

AMALGAMATED SHORT WAVE PRESS LTD.

57, Maida Vale, Paddington, London, W.9.



Radio Constructor

Vol. 5, No. 6 Annual Subscription 18/- January, 1952

Editorial and Advertising Offices—57, Maida Vale, Paddington, London, W.9
Tel. CUNNINGHAM 6518.

Edited by G. W. C. OVERLAND, G2ATV

CONTENTS

Suggested Circuits: A Transistron Inductance Meter, by G. A. French - - - - -	202
'R.C.' Quiz, by W. Groome - - - - -	204
Radio Control of Models, by A. C. Gee, G2UK - - - - -	205
Converting the 21 Receiver, by J. R. Davies - - - - -	207
In Your Workshop, by J.R.D. - - - - -	212
Modification of the "1143" Transmitter Unit for 2 Metre Operation, by John L. Emmert - - - - -	216
Harmonic Drive, by P. Turner - - - - -	219
A Single Valve Signal Generator, by A. W. Wood, B.Sc. - - - - -	224
Loudspeaker Baffles and Enclosures, by J. R. Davies - - - - -	230
Query Corner - - - - -	233
Radio Miscellany, by Centre Tap - - - - -	236
An Auto Scale Searching Light, by P. Johnstone - - - - -	238
Mailbag - - - - -	240

RESOLUTION!

With this, the first issue of the New Year, we look back at our progress during 1951, and pause in the making of tentative plans for improvements during 1952, to contemplate a furtherance of this progress.

Perhaps our greatest achievement during the past year is invisible to our readers. We refer, of course, to our greatly expanded circulation. By this means, we have been enabled to avoid an increase in the selling price, despite rising prices generally and printing costs and paper in particular.

Our increased circulation is a source of gratification to those on the Editorial side: not only because of the resultant widening of the circle of friends we make through our columns, but we feel the growth of our influence is serving to strengthen the well-being of the hobby.

In this connection, we would like to acknowledge the many suggestions received, from time to time, from readers, which have assisted us in reflecting, in these pages, the interests of all classes of readers. Confident that this policy has amply rewarded our efforts, we look forward to yet greater success in the ensuing year.

NOTICES

THE CONTENTS of this magazine are strictly copyright and may not be reproduced without obtaining prior permission from the Editor. Opinions expressed by contributors are not necessarily those of the Editor or proprietors.

THE EDITOR invites original contributions on construction of radio subjects. All material used will be paid for. Articles should be typewritten, and photographs should be clear and sharp. Diagrams need not be large or perfectly drawn, as our draughtsmen will redraw in most cases, but relevant information should be included. All Mss must be accompanied by a stamped addressed envelope for reply or return. Each item must bear the sender's name and address.

COMPONENT REVIEW. Manufacturers, publishers, etc., are invited to submit samples or information of new products for review in this section.

ALL CORRESPONDENCE should be addressed to Radio Constructor, 57, Maida Vale, Paddington, London, W.9. Telephone: CUN. 6518.

Suggested CIRCUITS for the EXPERIMENTER

The circuits presented in this series have been designed by G. A. FRENCH specially for the enthusiast who needs only a circuit and the essential relevant data.

No. 14: A Transistron Inductance Meter

LAST month we gave a suggested circuit for a capacitance meter in which the unknown capacitance was used to tune an inductor, a reading then being taken of the frequency of resonance. In this month's circuit something of the same principle is used to find unknown values of inductance. The inductor under test is connected to a transistron oscillator and, when paralleled by a known value of capacitance, its resonant frequency read with the aid of an external signal generator. By the use of two different parallel capacitors it is also possible to obtain a measure of the self-capacitance across the inductor.

The Circuit

The most important part of the circuit centres around the transistron oscillator, V1. This is a conventional RF pentode whose suppressor-grid is made negative with respect to its cathode, and whose screen-grid is given a higher positive voltage than its anode. The oscillator works on a portion of its screen-grid current-voltage curve which produces negative resistance. Due to this negative resistance no feedback coil is necessary for the inductor under test, and it may be made to oscillate by the use of a simple two-terminal connection.

To maintain the necessary voltages on the electrodes, two pre-set potentiometers, R7 and R8, are connected across the HT line. The values of resistance given in the circuit for these two components are a little low but, in the interests of stability of operation, such low values can be relied upon to err on the "safe side" for the different practical models which may be built.

The range of the transistron oscillator varies from low audio frequencies up to approximately 50 Mcs.

The oscillatory voltages obtained from the test inductor are applied to a leaky-grid detector, V2, via the 10 pF capacitor, C6. The output of an attenuated signal generator is also applied to the same valve. A further valve, V3, then amplifies the AF output from V2 and passes it to the headphones. The AF amplifier is necessary as the output from both the transistron and the signal generator will be low.

Once the frequency of oscillation given by the unknown inductor has been obtained, the value of its inductance will be given by the following formula:—

$$L = \frac{(2\pi f)^2 C}{f^2}$$

where L is in henrys, C in farads, and f in cycles per second.

If the meter is to be used consistently a graph of inductance against frequency can be plotted, using the capacitance values already installed in the meter.

Practical Details

The construction of the meter should not present a great deal of difficulty. The wiring to the oscillator valve must be kept short in order to reduce self-capacitance and to give efficient working at high frequencies. The resistor, R5, is panel-mounted and its leads may be of any convenient length so long as C10 is mounted close to the valve. The same applies to R8 and C11.

When the meter has been completed, the pre-set resistors R7 and R8 may be set up for optimum results. To do this, R8 should primarily be set about a third of the way up and R7 set to apply a slight negative voltage to the suppressor grid (with relation to cathode). R5 should be set to maximum. An inductor may then be connected across

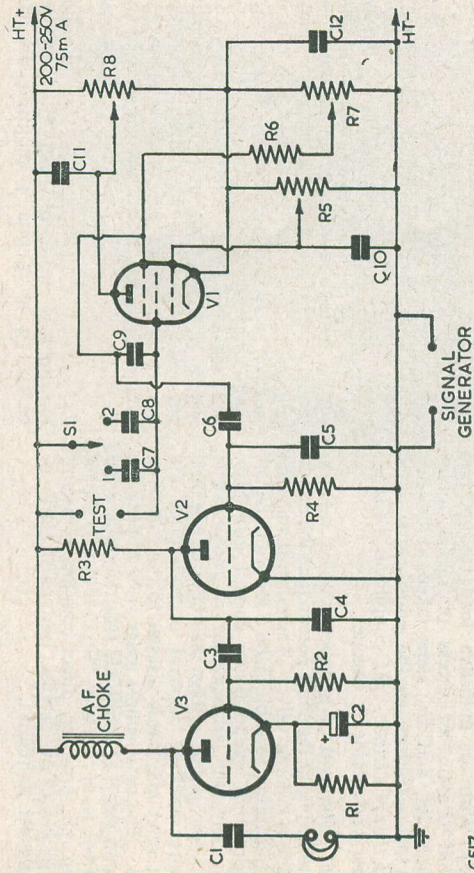

C57

List of Values

Resistors	
R1	1 kΩ
R2	250 kΩ
R3	50 kΩ
R4	1 MegΩ
R5	250 kΩ (Panel-mounted)
R6	100 kΩ
R7	1 kΩ; 5 watts. (Pre-set)
R8	3 kΩ; 10 watts. (Pre-set)

Capacitors

C1	0.1 μF
C2	25 μF; 25V wkg.
C3	.01 μF
C4	500 pF

C5	50 pF
C6	10 pF
C7	100 pF; High Stability ± 2% or better
C8	500 pF; High Stability ± 2% or better
C9	200 pF
C10	11, 12 0.1 μF

Valves

V1	6K7, EF39; (or most other RF pentodes with separate suppressor-grid connection)
V2, 3	6J5, 6C5, etc., etc.

the test terminals and the switch S1 set to position 1.

The oscillator will probably function straightaway, a beat-note being obtained from the external signal generator when it is set to the correct frequency. If oscillations do not commence immediately, R7 should be adjusted. In extreme cases it will be necessary to adjust R8 as well. Once a satisfactory beat-note has been obtained, R7 and R8 should be adjusted to give the strongest oscillations. (The adjustments to these two potentiometers will probably be interdependent). R5 should then be turned down until the beat-note is just audible; whereupon the process can be repeated. Once they are set up, R7 and R8 will need no further alteration. Indeed, they can be replaced by fixed resistors, if this is desired.

For very accurate readings, it will be necessary to take into account the internal stray capacitances in the meter itself. These could be measured across the test terminals, with one of the paralleling capacitors temporarily unsoldered and with V1 plugged in (the power supply being switched off); and should be later added to the value of capacitance switched in by S1. The effect of the stray capacitances will not be so great when S1 is switched to position 2.

Self-Capacitance

Assuming that the self-capacitance in the inductor under test may be considered as an additional capacitor connected across it, a measure of this self-capacitance can be obtained from the frequency readings

Radio Control of Models

By A. C. GEE, G2UK.

IN the previous article in this series, we described the installation and tuning-up of the E.D. Mk 111 receiver in a model aircraft. Whilst R/C has obviously a very useful application to model aircraft, the beginner in this sphere is well advised to try his initial experiments in a rather more robust craft, which also has the additional advantage of being able to carry a greater weight of gear. You will find that once it becomes known that you have a radio controlled model working, all sorts of visitors will present themselves with the request that you show them "how the wheels go round". One of the disadvantages from the demonstration point of view of the aircraft installation is that the life of the batteries is so short that frequent experiments or demonstrations become quite expensive. We have found, therefore, that our 30-inch electric launch makes a much better test bed and demonstration unit than our model aircraft.

This model is illustrated herewith, and its general features are well shown in the accompanying photograph. The launch was built up from a kit and is a model of the R.A.F. Seaplane Tender. It is driven by the small accumulators shown. The receiver is the same as that used for the model aircraft, viz., the E.D. Mk 111 using the Hivac XFG1 gas triode. It is slung by means of elastic bands just forward of the electric motor—which is disguised

by means of its plastic casing to resemble a Perkins Diesel engine. The switch, potentiometer and HT current test socket are fixed to the bulkhead, as shown. The aerial is made up of fine copper wire, threaded through holes in paxolin washers and twisted together to form a quite realistic looking cage aerial. The aerial is continued forward as a single wire to form a forestay for the wooden mast, and is connected to a small feed-through insulator on the foredeck. A length of insulated wire is run from this to the aerial tag on the receiver. The aerial is kept taut by a rubber band from its after end down to a cleat on the stern.

The batteries used can be considerably larger than those used in the model aircraft, as weight and space considerations can be more generous.

For the HT, one half of a Drydex Type 526 Drymax 90V battery makes an admit-

ter. The receiver is the same as that used for the model aircraft, viz., the E.D. Mk 111 using the Hivac XFG1 gas triode. It is slung by means of elastic bands just forward of the electric motor—which is disguised

by means of its plastic casing to resemble a Perkins Diesel engine. The switch, potentiometer and HT current test socket are fixed to the bulkhead, as shown. The aerial is made up of fine copper wire, threaded through holes in paxolin washers and twisted together to form a quite realistic looking cage aerial. The aerial is continued forward as a single wire to form a forestay for the wooden mast, and is connected to a small feed-through insulator on the foredeck. A length of insulated wire is run from this to the aerial tag on the receiver. The aerial is kept taut by a rubber band from its after end down to a cleat on the stern.

The batteries used can be considerably larger than those used in the model aircraft, as weight and space considerations can be more generous.

For the HT, one half of a Drydex Type 526 Drymax 90V battery makes an admit-

ter. The receiver is the same as that used for the model aircraft, viz., the E.D. Mk 111 using the Hivac XFG1 gas triode. It is slung by means of elastic bands just forward of the electric motor—which is disguised

given on positions 1 and 2 of S1; these readings being used to form a quadratic equation.

Harmonics

It may sometimes be possible to obtain false readings from the meter due to the presence of harmonics given either by the signal generator or by the transistor oscillator. These harmonics will, however, be very much weaker than the fundamentals; particularly so when both the signal generator and the oscillator are set to give low outputs. Once a beat-note has been obtained, the output of the transistor should be reduced (by adjusting R5) until it is approached by the "just audible" stage. The signal generator should then be attenuated until this stage is actually reached. Should no other beat-notes be obtainable, then it will be certain that the indications obtained are given by the fundamentals.

"Radio Constructor" QUIZ

Conducted by W. GROOME

- (1) Mr. Brain's TV receiver was of excellent design, and he was satisfied that its response was adequate and his aerial beyond reproach. He was therefore surprised to find that the 2.5 Mcs bars could not be distinguished on test card 'C'. What was wrong?
- (2) For what reason is it sometimes recommended that an output pentode should work into a lower load than that which gives the maximum gain?
- (3) What steps would you take to prevent "parasitic" oscillation in an AF amplifier?
- (4) It is true that a cathode ray tube will "explode" if the glass is broken?
- (5) What objection is there to the use of a transformer as inter-valve coupling after a pentode voltage amplifier?
- (6) What essential precaution is necessary in the use of direct coupling between valves?

ANSWERS IN NEXT COLUMN

ANSWERS TO QUIZ

- (1) The use of a long, screened connection between video output and CRT may cause noticeable loss of definition unless the output stage is a cathode follower. Assuming that this has been taken care of, and that the lines of the raster are fine, a likely explanation of poor definition is astigmatism, showing in this case as a horizontal elongation of the spot. External magnetic fields may cause a similar effect.
- (2) Odd-harmonic distortion is very noticeable with a large load, and for this reason a low load is chosen for a pentode.
- (3) Grid stopper resistors, soldered directly to the tag on the valve holder, rather than on a group board, often cure the irritating rattle of parasitic oscillation. Further aids are the use of resistors of about 100 Ω between the anode and its load, and negative feedback. "Stoppers" are often employed in circuits already having negative feedback, too. When an output pentode or triode is strapped as a triode, it is sometimes necessary to include about 100 Ω between screen grid and anode.
- (4) The correct term is "implosion" rather than "explosion", because there is a violent collapse instead of an expansion. A CRT should be handled with respect, for with its high vacuum the envelope has to support a loading of atmospheric pressure which may amount to well over a ton. Fortunately, due to design and strength of manufacture, this dangerous (and expensive) accident seems to occur but rarely.
- (5) With an inductive load, the output would contain an excess of higher audio frequencies, and any steps taken to balance the tone would reduce the gain to little more than that of a triode. RC coupling is therefore better and decidedly cheaper.
- (6) The grid of a direct coupled valve is bound to be at the same potential as the anode of the preceding valve. Therefore it must be arranged that its cathode be a few volts higher in order to maintain the correct grid bias. Generally, the arrangement is complicated; variations in HT voltage may have unwelcome results, and the removal or failure of the first valve may cause disaster to the following one. The most simple usage is to employ the second valve as a cathode follower, where the cathode is, of necessity, "up in the air". Apart from AF, however, direct coupling is useful, as in some TV circuits, and particularly in biological amplifiers.

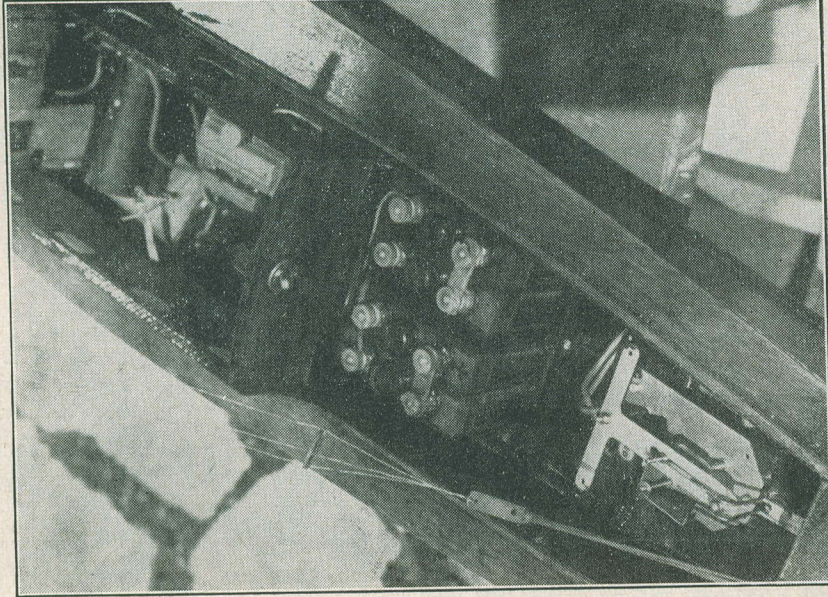

able 45V HT supply. If you take the outer card covering off this battery, you will find inside two layered batteries approximately $3\frac{1}{2} \times 1\frac{1}{4} \times 1\frac{3}{4}$ which can be separated from one another and used as separate 45V batteries. LT is supplied by a Drydex Type DL17 1.5V battery, or if weight is of no consideration the Drydex Type H.1184 will do excellently.

It is quite interesting to notice how fashions in our hobby suddenly come to the fore because some often quite insignificant but vital piece of equipment suddenly becomes available. This is very true of the radio control of models. The availability of sensitive relays on the one hand has helped the constructor enormously, and the marketing of actuators by commercial firms has helped greatly by making available an essential piece of equipment which was beyond the constructional facilities available to the average constructor. Particularly is the latter point the case in regard to suitable steering mechanisms for boats. In our last article, we described the rubber powered steering mechanism suitable for small model aircraft. E.D.'s make a more powerful clockwork driven steering mechanism which can be used for boats up to six feet long or the heavier type of model aircraft. This steering motor can be well seen in the accompanying photograph. It can be wound up by rotating the star wheel by means of the striker pin on one of its arms, and will then deliver 200 or so turns when released step by step by the electromagnet which is, in its turn, controlled by the relay on the receiver. The rudder can be controlled either by wires

from it to the T bar on the steering mechanism, or by an extended stiff wire tiller which engages with the striker pin as shown in the photograph.

This steering mechanism is supplied with two types of release pawl. One has four arms, the other two. If the four arm one is fitted, each impulse of the receiver relay will permit the striker arm to rotate 45° only, so that the rudder sequence is, say—port, centre, starboard, centre and so on, with each impulse from the transmitter. If on the other hand the two arm pawl is fitted, it becomes necessary to hold the transmitter switch down to maintain the rudder to either port or starboard, otherwise a 180° rotation takes place and the rudder returns to centre. The moment the carrier is interrupted, the receiver relay lifts and the steering mechanism brings the rudder to centre. The advantage of the two position steering against the four is that if a fault develops, the rudder returns automatically to centre so that the boat continues on a straight course and will make its way back to the edge of the pond. If a failure occurs with the four arm pawl and it happens to stick in the port or starboard position, the boat will continue to circle in the middle of the pond! Readers are advised to try both pawls, and familiarise themselves with the different operating procedures.

In the next article in this series, we shall deal with the construction of a two valve R/C receiver using a readily available surplus relay.

Converting the 21 RECEIVER

By J. R. DAVIES

The second of a series of articles describing the conversion of this well-known ex-Government receiver.

22. Carrying on with the modification of the receiver, it is next necessary to unsolder the temporary HT negative lead (used originally for checking the receiver) from tag 5 of the rear plate; and to remove also the temporary 100 Ω resistor. Connect an additional lead from this tag to pin 3 of Spare Valveholder 2.

23. Connect an additional 100 Ω resistor (the one just removed from its temporary connection may be used, if desired) between pin 3 and pin 6 of Spare Valveholder 2. Connect an additional 250 Ω resistor between pins 3 and 8 of the same valveholder.

24. Run a lead from tag 8 of the rear plate to pin 8 of Spare Valveholder 2. Reconnect the temporary HT negative wander lead to tag 8 of the rear plate.

25. A 75 k Ω resistor is connected between the two third tags from the rear, top and bottom of the tagboard. Disconnect the red lead from its bottom tag and cut it back to its harness.

26. The other end of this red lead is bound together with a red and white lead and an orange lead; the three being originally connected to the output transformer. Remove the thread lacing these three wires together and cut both the red lead and the orange lead back to the harness. Disconnect the other end of the orange lead from pin 3 of valveholder V2B and cut it back to the harness.

Connect the centre lead of a seven-inch length of screened wire to pin 3 of V2B, earthing the screening at pin 5 of the same valveholder.

27. Mount the new speaker transformer in the position occupied by the old output transformer. The Premier model recommended can be fitted directly to the holes

used previously by the output transformer, further drilling being unnecessary.

28. Connect one side of the secondary of the speaker transformer to pin 6 of Spare Valveholder 2. Connect the other side to the black lead from tag 2 of the rear plate (Step 5).

29. The red and white lead (all that is left of the three wires mentioned in Step 26) is now connected to one side of the speaker transformer primary. The red lead from tag 1, rear plate (Step 5), is connected to the same transformer tag. To the other primary tag is connected the screened lead from pin 3 of V2B, shortened as necessary. The screened lead must be insulated with sleeving, and may be tied to the main harness for security. The 300 pF capacitor of Step 3 is connected across the primary tags.

30. Two green leads are connected to the earthy tag (i.e. the tag at the "bottom" of the track, corresponding to minimum volume) of the volume control. Remove these leads, allowing them to remain connected together, and insulating the joint with sleeving. Connect an additional lead between the now-vacant volume-control tag and pin 8 of Spare Valveholder 2.

31. Remove the wire bonding pins 5 and 6 of V2B together. Disconnect the green lead from pin 4 and reconnect it to pin 5. Remove the 120 k Ω resistor joining pin 4 to an adjacent tag on the centre wave-change wafers. The green top-cap fly-lead from this wave-change switch tag is also removed.

32. Connect pin 4 of V2B to the top of the 75 k Ω resistor mentioned in Step 25. Remove the 75 k Ω resistor.

33. Remove the 75 Ω (filament-dropping) resistor joining pins 8 and 2 of V2B and

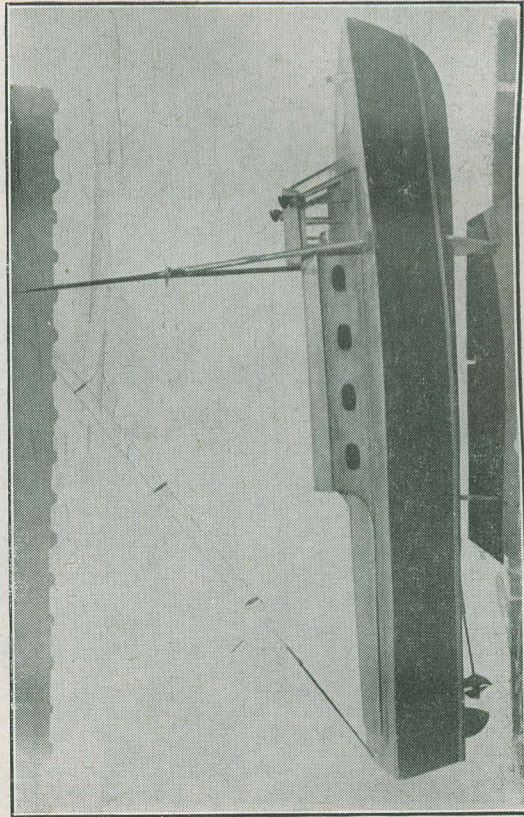

stages may be tested with an attenuated signal generator for sensitivity. Alternatively, an aerial touched to the grid of VIC will cause any local man-made interference (electric motors, etc.) to be picked up and amplified. Apart from a slight hiss there should be no self-generated noise or instability whatsoever. After the test has been completed the batteries should be disconnected again. The temporary lead of the preceding Step should also be removed.

After the IF stages have been finished and checked, it becomes necessary to remove some more components before the new RF tuned circuits can be fitted.

40. To the right of the wave-change switch (chassis upside-down again) is an SPST tumbler switch. A black lead from this switch connects to a small metal rectifier above the chassis. Remove this rectifier and the lead. (The rectifier is mounted by a single long 6BA bolt and nut). To the other contact of the switch is connected a black lead which passes through the harness to tag 2 of the rear plate. Disconnect this lead at tag 2 and cut it back to the harness. Similarly disconnect it at the switch end, cutting this end also back to the harness. Remove the switch.

41. To the left of the volume control is an SPDT tumbler switch. Identify the white and black lead from its top right-hand tag travelling through the harness to tag 11, rear plate. Disconnect this lead at both ends and cut both ends back to the harness.

42. Two other leads (one white, one black) are also connected to the SPDT switch. Disconnect these leads and remove the switch. (After its bush nut has been removed, the switch should be turned to a vertical position, whereupon it may be pushed past the right-hand side of the 6 kΩ resistor behind it). Trace the white and black leads to the panel above the chassis, disconnect at the tags on this panel and remove the leads.

43. Turn the chassis right way up and remove valves VIA, VIB, VIC and VID from their valveholders.

44. Remove the paxolin cover over the tuning capacitors. (This is held by three 6BA bolts screwing into tapped angle brackets at the side, and by two 4BA nuts on top). To facilitate removal, disconnect the top-cap connector to VIB from its fly-lead.

45. The 5-gang tuning capacitor will now be visible. Identify five separate leads travelling through grommets in the chassis to the five sets of fixed vanes. Cut all five leads just above the grommets. A sixth

connect these pins together. Similarly remove the 75 Ω resistor across pins 8 and 2 of V2A and short out the pins.

34. Trace the green fly-lead from the top-cap of valve V2A to a contact on the wave-change switch. Replace this lead by a screened lead whose screening is earthed at pin 1 of V2A.

Checking the AF Stages

35. The AF stages are now wired up and may be checked. Connect a loudspeaker (about 2-3 ohms if the Premier transformer is used) between tag 2, rear plate and chassis. Remove the AR8 from valveholder V2B and fit the Pen25 in its place. Connect a 2-volt accumulator (*not* 6 volts this time!) to the LT leads; and 120 volts to the HT leads.

The AF stages should be sensitive and "lively", and there should be no instability. If the top-grid of valve V2A is touched with the finger there should be a loud hum, click, or similar noise. Badly earthed metallising on valve V2A will cause instability. It should be remembered that the other valves in the receiver will not be working yet as their filament-dropping resistors are still connected.

After the AF stages have been checked, the batteries should be once more disconnected. The process of conversion is then resumed, carrying on to the next step.

Modifying and Testing the IF Stages

36. Remove the filament-dropping resistor from pins 7 and 8 of V1F, and connect these two pins together.

37. Similarly remove the resistor across, and short out, the pins 7 and 8 of V1E.

38. Remove the resistor across pins 7 and 8 of V1C. Disconnect and remove the black and white lead from pin 7 of V1C to pin 2 of V1B. Connect a temporary lead from pin 8 of V1E to pin 8 of V1C. (This lead is fitted temporarily in order to test the IF stages, and it will afterwards be removed).

39. The IF stages should now be working from the top-grid of V1C onwards. After reconnecting the battery supplies the IF

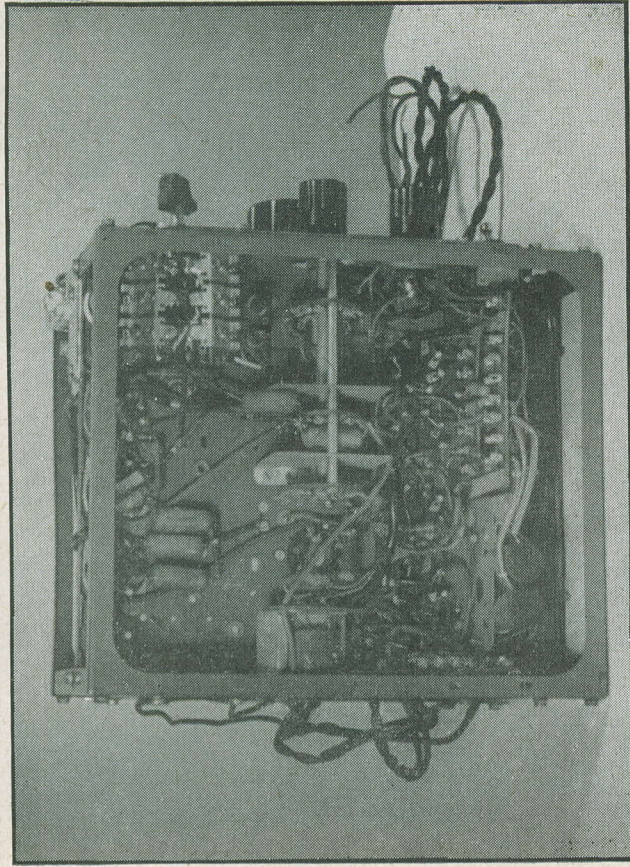

Under-Chassis view of the Converted Receiver.

green lead passes through a grommet adjacent to Spare Valveholder 2 and connects to a tag-board mounted between the two tuning capacitors. Disconnect at the tagboard and leave the lead available for re-connection later.

46. Identify the small coil at the rear of the chassis and above it. (See Step 15). Disconnect the two leads connected to it (one orange, one black and white) and remove the coil.

Removing the Coil Chassis

47. Turn the chassis upside down again. Disconnect all the wires to VIA at the valveholder tags, with the exception of the short wire bridging pins 5 and 6.

48. Disconnect the leads from the VIB coil to pins 4 and 5 of VIB; disconnecting at the valveholder tags. Identify a black and red lead from the harness connecting to the front right-hand tag of the VIB coil. Disconnect this lead at the coil tag. Through the base of this coil runs a screened lead terminating at the centre wave-change wafer. Disconnect this lead at the wave-change contact, and disconnect also its screening from the adjacent earth tag. Remove the cleat holding the screened wire to the chassis and retain it for later use.

Identify an orange lead from pin 3 of VIB to the VIC coil. Disconnect this lead at pin 3, pull out from the chassis, and disconnect again at the coil tag. Remove the lead.

49. Identify the 25 kΩ resistor and its parallel waxed capacitor connected to pin 2 of VID and unsolder both components at pin 2. Bend the two components out of the way. Disconnect, at pin 5, the short lead from pin 5 of VID to the VID coil. Similarly treat the orange lead to pin 3 of VID. Identify two leads from the harness (red and blue to the top and red and yellow to the bottom), connecting the two front left-hand tags of the VID coil. Disconnect these leads at the coil tags. Disconnect all leads from pin 2 of VID. This will free a top-cap fly-lead, which is removed. Disconnect the blue lead from the VID coil to pin 3 of VID at pin 3.

50. Disconnect a short green lead from pin 5 of VIC and remove the lead. Identify the blue lead from IFT 1 to pin 4 of VIC. Carefully unsolder this lead at pin 4 and gently pull it back through the hole in the base of the VIC coil until it is free. Identify the screened lead from the same IF transformer to pin 3 of VIC. Remove the cleat

Valve	Pin Connections	Pins	Top-cap
ARP 12	1 Fil, 2 Anode, 3 Screen, 4 Grid, 5 Screen Supp., 6 Met. Grid	5, 6	8
ARP 8	1 Fil, 2 Anode, 3 Diode, 4 Screen Supp., 5 Grid	5, 6	8
Pen 25	1 Fil, 2 Anode, 3 Diode, 4 Screen Supp., 5 Grid	5, 6	8

N.B. Pins 2 and 7 are blank on all valves.

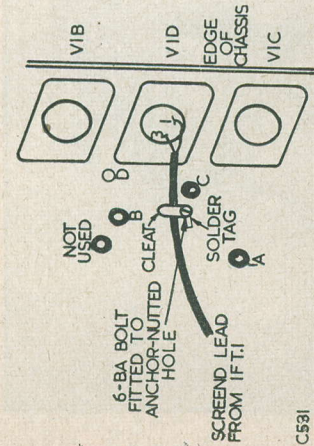

C531

Fig. 4: The new position for the screened cable from IFT 1 mentioned in Step 54. The references to grommets A, B and C, and to the plain hole D, are intended for later steps in the conversion.

holding the lead on the left-hand side of the coil chassis and retain for later use. Again working carefully, unsolder the screened lead from pin 3 of VIC; and also its screening from the VIC coil earthing tag. (The screened wire remains where it is for the time being).

Disconnect, at the coil tag, the black lead from pin 1 of VIC to the coil earthing tag just mentioned. Identify the two harness leads, one red and green to the top and one red and white to the bottom, connecting to the two left-hand front tags of the VIC coil. Disconnect these leads at the coil tags.

51. Identify the 5-35 pF silver-ceramic trimmer mounted on the screen between the front two wave-change wafers. Disconnect the green lead connecting this trimmer to the VIC coil at the trimmer tag.

52. Remove the screws holding the coil chassis. These consist of nine 6BA screws beneath the coils, these fitting into tapped anchor nuts or brackets on the receiver-chassis itself.

53. Carefully remove the coil chassis, gently easing the screened lead from IFT-1 through the hole in the base of the VIC coil until it is free.

The coil chassis will be found very useful in later stages of the conversion because, apart from the resistors and capacitors mounted on it, it also provides plenty of such things as 6BA bolts and solder tags.

54. Reconnect the blue lead from IFT 1 (removed in Step 50) to pin 4 of VID (not from IFT 1 to pin 3 of VID, and the screening from IFT 1 to pin 3 of VID, and the screening to pin 1 of the same valveholder. Re-lead the screened cable in the new position shown

in Fig. 4, fitting also an earthing solder tag under the screw-head.

55. Remove all leads from pins 1 and 7 of VID, and from pin 2 of VIB. Remove the wire joining pins 5 and 6 of VID. Remove the resistor bridging pins 7 and 8 of VID, and that bridging pins 2 and 8 of VIB.

56. Remove from the chassis the three small tapped angle brackets mentioned in Step 44.

57. Identify the earthing tag to the right of the centre wave-change wafer. A black lead from this tag travels to the wafer itself. Disconnect the lead at the wafer contact and remove lead, earthing tag, and its bolt completely. (This also frees one of the tuning capacitor connections). Remove the .01 μ F capacitor connected across the contacts of the centre wafer. Remove the 5-35 pF trimmer mentioned in Step 51, disconnecting its remaining green lead at the centre wafer tag.

Removing the Tuning Capacitors

58. To the right of Spare Valveholder 2 is a now-unused earthing tag. Remove this tag and its bolt.

59. At the front of the chassis, to the right of the wave-change switch, are two 5BA bolts about 2½ inches apart. Remove and retain these bolts, removing also the earthing tag held under one of them.

60. Put the chassis right way up again, and remove the two 4BA bolts holding the rear tuning capacitor bracket.

61. To the left of the tuning drive is a 6BA bolt fastening it to the outside frame. Remove this bolt.

62. Remove the two top front outside 4BA bolts holding the top frame. Remove also the two 6BA bolts and nuts holding the top of the panel mentioned in Step 42.

Slightly raise the top frame at the front, and pull out the drive and tuning capacitor assembly to the front. The assembly is still connected by a green lead connecting to a three-way tagboard mounted at its front. This lead should be long enough to allow the removal of the assembly, and it should not be broken.

63. Unsolder, at the three-way tagboard, the green and white lead connecting the foremost trimmer of the assembly to this tagboard.

64. Remove the tuning capacitors from the drive. (Two 2BA nuts at the front, and two grub-screws).

65. Fit the new 500 pF 3-gang tuning capacitor to the drive by using the same 2BA nuts and holes. The ¼ inch spindle of the new capacitor may be built up to the

MODERN PRACTICAL RADIO AND TELEVISION

This work covers every phase of Radio and Television Engineering from many viewpoints and meets a great demand. The author, C. A. Quarrington, A.M.B.I.R.E., has been responsible for training Radio and Television Service Engineers and is also well known as a lecturer on Radio and Cathode-ray subjects.

SOME OF THE CONTENTS

Sound — Waves in Free Space — Electricity — Magnetism and Inductance — Capacity — Reactance and Impedance — Alternating Current — Tuned Circuits — Principles of the Thermionic Valve — The Signal Analysed — Detection — Reaction and Damping — H.F. Tetrode and Pentode — High-frequency Amplification — Principles of the Superheterodyne — Frequency-changing Valves — Design of the Superheterodyne — Practical Coil Design — Switches and Switching — Low-frequency Amplification — The Output Stage — Output Valves — Loudspeakers — Automatic Volume Control — Tuning Indicators — Inter-Station Noise Suppression — Automatic Tuning — Frequency Modulation — Power Pack — Decoupling — Gramophone Pick-up — General Mechanical and Electrical Considerations — Five Circuits Analysed — Aerials, Fiches, and Noise Suppression — Car Radio — Principles of Low-power Transmission — High Vacuum Cathode-Ray Tube and its Application to Television — Time Base — Television Technique of a Television Receiver Design — Adjustments and Faults of a Television Receiver — Measuring Instruments — Ganging Oscillator — Cathode-ray Oscillograph — Voltage and Current Testing — Instability and Motor-boating — Tracing Distortion — Tracing Main Hum — Tracing Background Noise — Valve Testing — Receiver Alignment (Ganging) — Whistles and Break-through — Loudspeaker Faults — Testing Components — Faultfinding Procedure (A Summary) — Local Interference — Workshop Hints — Accumulator Charging and Maintenance — Simple Mathematics, etc. — Abridged Technical Dictionary.

RADIO CIRCUITS AND DATA

A large selection of typical and basic circuits with formulae and data, are also included together with a number of Manufacturers' and complete basic circuits showing the latest trends and practice, apart from a comprehensive range of unit circuits.

THE ILLUSTRATIONS

"Modern Practical Radio and Television" is profusely illustrated. It contains 16 full-page plates, over 400 diagrams in the text and 7 large folding inserts. Each illustration has been specially selected for its practical utility.

SEND FOR FREE PARTICULARS

To The Caxton Publishing Co., Ltd.,
73, Morley Hall, St. George Street, Hanover Square,
London, W.1.

Please send me, free of charge, particulars of "Modern Practical Radio and Television," together with your terms of easy payment.

Name.....

Send this form in unsealed envelope. (14d. stamp)

Address.....

R.T.9.....

NEXT MONTH

We present the first of a series of articles describing conversion to large screen TV, using the English Electric 16" Tube.

(To be continued)

ADDITIONAL TRIMMERS MOUNTED ON BRACKET

(A)

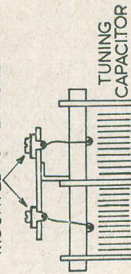

SCREEN FITTED BETWEEN TRIMMERS AND WIRING

(B)

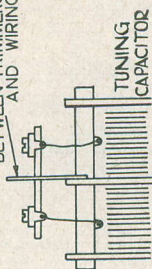

C520

Fig. 2 (a): When two extra trimmers are mounted to a tuning capacitor, as shown here, capacitive coupling may exist between their fixed vanes and their wiring.
Fig. 2 (b): This coupling can be removed by fitting a screen between the trimmers, as illustrated here.

respectively to the earthed screen. The result of this is that both A and B are now coupled capacitively to the screen and not to each other at all; and the original unwanted coupling is therefore effectively removed. In practice, of course, the screen is connected to earth by mounting it to the chassis of the equipment being used, this then providing the earth connection. It must be noted, however, that if the new capacitances introduced by the presence of the screen (C2 or C3 in Fig. 1 (b)) are relatively high, the performance of the circuits connected to the conductors A and B may suffer. Particularly is this true if either or both of the conductors form part of a tuned circuit.

This method of capacitive RF screening is, of course, used in screen-grid and pentode valves in order to screen the control grid and anode away from each other; the only difference being that the screen-grid is connected to chassis via a large-value capacitor instead of by using the direct connection. The writer mentions this example in passing in order to emphasise the necessity of connecting the screen of Fig. 1 (b) to chassis. Try disconnecting the screen-grid capacitor of an IF amplifying valve and see what happens!

Fig. 1 (b) does not really present an ideal solution to the problem because it is possible for a capacitive coupling to still exist, the coupling being formed, as it were, around the edges of the screen. It may also happen that one of the conductors takes up a considerably larger space than that of Fig. 1 (b). Fig. 1 (c) shows a possible instance in which a large-area conductor A is liable to couple with the small conductor B. This time it may be necessary to use a screen of the type shown in this diagram, in which the second conductor is almost entirely screened away from the first. If, however, we are going to screen three sides of B, we might as well go the whole hog and screen it completely, as in Fig. 1 (d).

Practical Examples

We have, up to now, spoken only in general terms, referring to the unwanted couplings as existing between two "conductors". It is interesting to see how our theoretical cases can turn out to have strikingly similar practical examples.

Fig. 2 (a) shows a two-gang capacitor which, say, tunes the aerial and detector tuned circuits of a straight receiver. (Or the aerial and frequency-changer signal circuits of any superhet fitted with an RF amplifier). It may happen that the tuning capacitor is not fitted with trimmers by the

manufacturer and so, to meet the requirements of our particular receiver, we mount two trimmers on a bracket as shown in the diagram. So far so good!

Unfortunately, a small amount of capacitance will exist between the fixed vanes of each trimmer and between the fixed vanes. As these parts of the tuning circuits are connected to the "grid ends" of their associated tuned circuits, this small capacitance may cause sufficient coupling to introduce instability. The cure is shown in Fig. 2 (b), in which a small screen is mounted between the two trimmers, this being quite sufficient to remove the unwanted coupling.

This example is, incidentally, a perfectly true one, the writer having cleared a case of instability several years ago in exactly that manner. It is interesting to note also that it affords an exact parallel to Fig. 1 (b).

The case of Fig. 1 (c) also appears quite often in practice. For instance, we may find that we need to pass a lead from one point on a chassis to another without allowing it to pick up unwanted couplings from an intermediately-positioned component. We can often do this most conveniently by positioning the lead on the opposite side of the chassis from the intermediate component (above or below as the case may be) until it reaches the appropriate place. The chassis then provides the screening.

IN YOUR WORKSHOP

In which J. R. D. discusses Problems and Points of Interest connected with The Workshop side of our Hobby, based on Letters from Readers and his own Experiences.

ONCE more, the same old story!" This, incidentally, was the writer's inward comment on being introduced to a straight short-wave receiver knocked up by a juvenile but enthusiastic acquaintance. Apparently, the trouble with this set was that it would cope quite nicely until the RF coils were accurately trimmed to the same frequency as were the detector coils; after which the set burst into uncontrollable instability. The wiring was carried out correctly with short leads and all the decoupling circuits were above approach. The fault was obvious enough, however, and could almost immediately be seen to rest in the layout of the chassis. The RF and detector coils were mounted about

five inches apart, and were optically screened from each other by an upright piece of metal about four inches square. Additional screening was the answer to the problem and, after having been carried out experimentally, soon resulted in a stable and sensitive receiver.

The Purpose of Screening

It is true that the vast majority of constructors do allow themselves to ignore the necessity of employing adequate screening in their designs; certainly not to the extent just quoted. Nevertheless, the theory behind the use of screening is not always fully appreciated; and no harm would therefore result if we were to devote some space to it here.

First of all, then, let us begin by defining the purpose of screening. Why is it necessary? The answer to that is, of course, quite simple. The fundamental purpose of screening is to isolate one circuit from another in such a manner that no capacitive or inductive coupling exists between the two. This definition assumes that the second circuit is of a nature which is liable to be affected by the first (or vice versa); and that an unwanted coupling would cause detrimental effects to the equipment which employs the two circuits.

Capacitive Screening

Let us start with the case where we have unwanted capacitive coupling. This coupling is caused when two conductors are sufficiently close together to allow an appreciable value of capacitance to exist between them. As the coupling is capacitive its effective impedance decreases as the frequency of the currents in the conductors increases.

Unwanted capacitive couplings of this type are usually quite easy to clear. Fig. 1 (a) shows two conductors, A and B, between which there is an unwanted capacitance, represented by C1. All that is necessary to remove this capacitance is to insert a screen between the conductors, as is shown in Fig. 1 (b). This screen is connected to earth. We find now that, instead of C1, we have two separate capacitive couplings, C2 and C3, both of which couple A and B

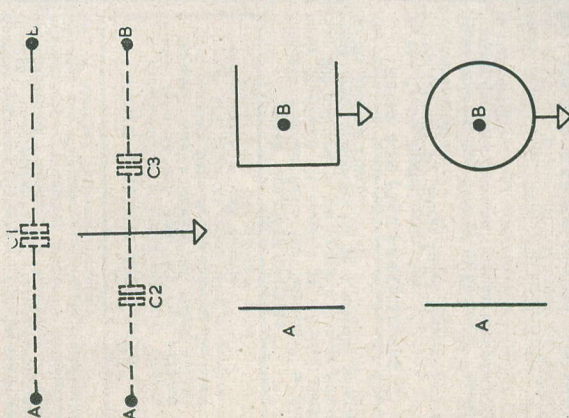
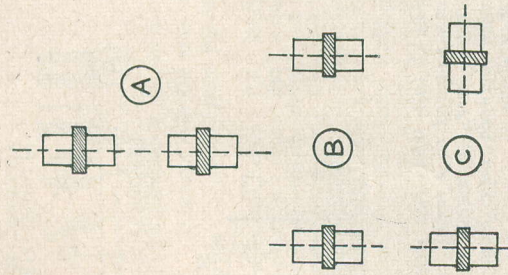

Fig. 1: The effect of different types of capacitive screening.

C519



C521

Fig. 3 (a) Two coils on a common axis.
Fig. 3 (b) Two coils whose axes are in a common plane.
Fig. 3 (c) Two coils whose axes are at right angles to each other.

The totally enclosed screening of Fig. 1 (d) is found mainly (so far as capacitive coupling is concerned) in the form of screened wire. Unfortunately, screened wire usually presents a high capacitance between the outside screening and the screened conductor, and care has to be taken to see that this does not upset the functioning of the circuit in which it is used.

It can be seen from what we have already said that unwanted capacitive coupling is quite simple to visualise in practice, and that the requisite screening to prevent it can usually be fairly easily worked out and incorporated in the original design of the equipment which needs it.

Inductive Screening

The screening required to prevent unwanted inductive coupling performs quite a different function from that used to prevent capacitive coupling. This is due to the fact that the nature of the coupling is itself different.

Inductive coupling is caused when two inductive components are placed sufficiently close, or in such a relative position to each other, that a value of mutual inductance exists between the two. To explain later the action of inductive screening it will help if we think

about this coupling by mutual inductance in its fundamental concept: that is, that such a coupling is caused by the varying lines of magnetic flux which exists around one component cutting the conductors of the second and thus inducing voltages in them.

Inductive coupling is most likely to exist between two coils or inductors. As, however, even a straight piece of wire can possess a small inductive field, it is well to remember that all wiring (and, indeed, all components for that matter) is theoretically capable of being affected by random inductive couplings. At the time being, we are more concerned here with the more practical examples of unwanted inductive couplings. In most cases, these will occur between two coils or inductors. If either or both of the coils form part of a tuned circuit, the unwanted inductive coupling is more liable to rise to an undesirable value than might otherwise be the case.

As we said just now, the mutual inductance existing between two inductors depends not only on their nearness to each other but also on their relative positions. If, for instance, two coils are positioned in line with each other (that is, on a common axis), as in Fig. 3 (a), the inductive coupling is at its highest. When the coils are placed side by side so that their axes are in the same plane (Fig. 3 (b)), the coupling is still quite high. If, however, the axes of the coils are at right angles to each other (Fig. 3 (c)), then the inductive coupling is reduced very considerably and is at its minimum.

Preventing Inductive Coupling

The procedure used to prevent unwanted inductive coupling varies with the frequency at which the coupling is liable to occur. Two types of screening are employed, one for radio frequencies and another for audio and mains frequencies.

Let us consider first of all the case for inductive screening at radio frequencies. A coil working at a radio frequency has around it lines of magnetic flux which vary at the frequency of the currents in the coil. Should these lines of flux meet and cut an external conductor they will induce in that conductor currents which produce an opposing field. If the second conductor happens to be a metal plate, the opposing fields set up by it will be sufficiently strong to almost completely neutralize the original field over the area of the plate. The plate does not screen the space on its "leeward side," very effectively, however, since the lines of flux from the coil follow curved instead of straight paths, and are therefore capable of "reaching round" to the other side.

an inductive field at 100 mcs is only 0.0014 ins. A screen as thin as this would be too weak to be used in normal practice, and minimum screening at such frequencies would be given mainly by the requirements of mechanical strength. However, an alternative scheme could consist of plating a metal such as steel with another metal of high conductivity, the latter forming the main part of the screen. Such a system is used in some VHF equipments.

At the low frequency end of the scale we find that the thickness of the metal needed for effective screening becomes quite large. Such thicknesses may not be entirely necessary in practice, particularly with such things as IF transformers where the coils are in their own separate cans and are thus doubly screened from each other.

Lament

What a pity it is that, after having proceeded so far on this subject, we find that we have reached our deadline and that we cannot continue without trespassing on other people's space! Still, it can't be helped and, rather than crush what remains to be said into several indigestible paragraphs, it would be better if we carried our discussion of screening technique over into the first part of next month's article.

SCREEN THICKNESS TABLE

Frequency	5×Skin Depth (Copper)	Nearest swg
100 kcs	0.04 ins.	19 swg
1 mcs	0.014 ins.	29 swg
10 mcs	0.004 ins.	42 swg
100 mcs	0.0014 ins	—

To give efficient inductive screening of a coil it is usual to totally enclose it in a metal container or can. If this is done, all the field external to the coil is bound to meet the metal of the can and be therefore subjected to neutralisation.

In order to ensure that the opposing field set up by the screening can be sufficiently strong to adequately oppose that of the coil, it is necessary to make the can of a metal which is a good conductor. Copper is a good choice for frequencies up to VHF and is used sometimes to screen signal generators and other laboratory gear. Much more popular is aluminium which, although not quite so good a conductor as copper, is cheaper, easier to handle, and lighter.

A further important point with reference to the conductivity of the metal used for inductive screening lies in the well-known tendency of radio frequencies to travel over the surface of a conductor instead of through its body. The result of this "skin-effect" is that the opposing fields set up by the screening can are not formed so readily as an original scrutiny of the conductivity of the particular metal chosen may lead one to expect.

A measure of the conductivity of different metals is given by what is known as "skin-depth". Most authorities recommend that, for screening purposes, the thickness of the screening metal should be a "number of times" that of the skin depth. The writer has made up a small table of recommended minimum thicknesses for different frequencies in order to give a guide to the practical figures involved. The minimum thickness has been chosen here arbitrarily as five times the skin depth, and appears in the table as such. The figures given, incidentally, have only been calculated approximately since a high level of accuracy is not necessary. The metal used is copper. Aluminium, with its lower conductivity, would need to be slightly thicker for a corresponding frequency.

It is interesting to note that the minimum thickness of metal needed to screen effectively

The Editor Invites

articles from readers, of a nature suitable for inclusion in this magazine. Articles submitted for publication should preferably be typewritten, but ordinary writing is acceptable if clearly legible. In any case, double spacing should be used, to allow room for any necessary corrections. Drawings need not be elaborately finished, as they will usually be redrawn by our draughtsmen, but details should be clear. Photographs should preferably be large (half-plate) but in any case the focus must be good. Much useful advice to prospective writers is given in our "Hints for Article Writers", which will be sent free on request.

Modification of the "1143" TRANSMITTER UNIT for 2 Metre Operation

By JOHN L. EMMETT

THIS well known surplus airborne unit (circuit Fig. 1) was originally designed for use over the range 90-124 Mcs, but when modified it makes a very compact and tidy transmitter for the two metre band. Unlike its American counterpart, the SCR522, it has no provision for internal modulation, but it will operate very well from a small external modulator.

It uses 6.3 volt octal valves throughout, and these are wired in series-parallel, as the original LI supply was from a 12 volt source. Modification of the heater wiring is quite easy. Pin No. 3 on the Jones plug is the unearthed heater, and this should be looped through to each valve in turn, removing the unwanted series connections as you go, and taking the earthed heater connection to chassis in each case. (It is quite easy to solder to this chassis). Coil L1 is situated on the opposite side of the chassis to V1 and is the crystal oscillator anode coil. No modification is necessary to this circuit if you are going to use a crystal in the 6 Mcs range. If you wish to use an 8 Mcs crystal, remove six turns from this coil.

Next, V2 circuit. This either trebles from 8 Mcs or quadruples from 6 Mcs. The coil L2 is next to L1, and this will require four turns removed to cover the 24 Mcs range.

V3 trebles to 72 Mcs, and L3 is the four turn coil made from silver plated No. 10 swg. It will be better to remove this coil entirely and re-shape it to form a hairpin loop to the dimensions given in Fig. 2.

L4 will be found under the chassis. This should be removed, after unsoldering the two grid coupling capacitors, and a new coil made up to the dimensions given in Fig. 2. Re-fit this coil, and re-solder the coupling capacitors one turn from each end.

L5 (Push pull anode coil) is situated in the screened compartment with the two output valves. Remove this entirely, and alter its shape by careful bending, until it assumes the appearance of Fig. 3. Cut off surplus ends and re-solder into position. On final test, it may be necessary to open out the turns somewhat, but this can easily be done with the coil in place. The existing aerial coupling loop is designed for 50 Ω feeder. It will be better to leave this in place, as the mis-match, over a range of 50 to 100 ohms, is not noticeable.

Biasing

The existing bias arrangements are not suitable for really efficient operation, and do not allow the output valves to run in class "C". The best procedure, therefore, is as follows:—Trace V2 grid lead to the bias end of the RF choke, disconnect bias lead and earth that end of the choke. Lift V2 cathode from earth, and fit a 470 Ω 1 watt resistor, by-passed with a 200 pF capacitor. Carry out precisely the same operation with V3 and V4. The output valves will require external bias supply. The connection to look for is the junction of the two grid chokes and a by-pass capacitor. With the chassis upside down, and the screened compartment towards you, this will be found in the near right hand corner. Disconnect

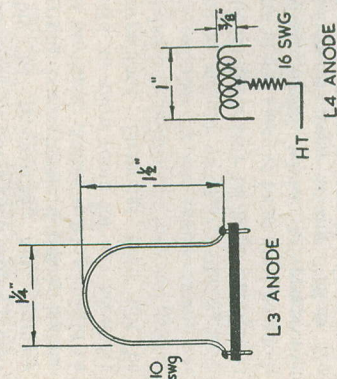

FIG. 2. L3 & L4 DETAILS

6871

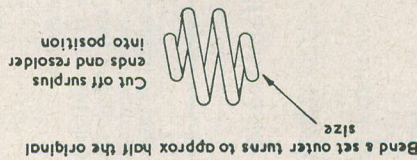
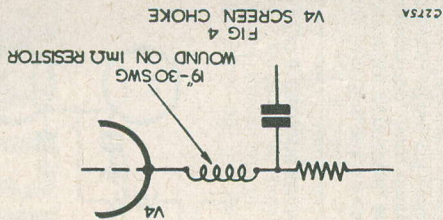
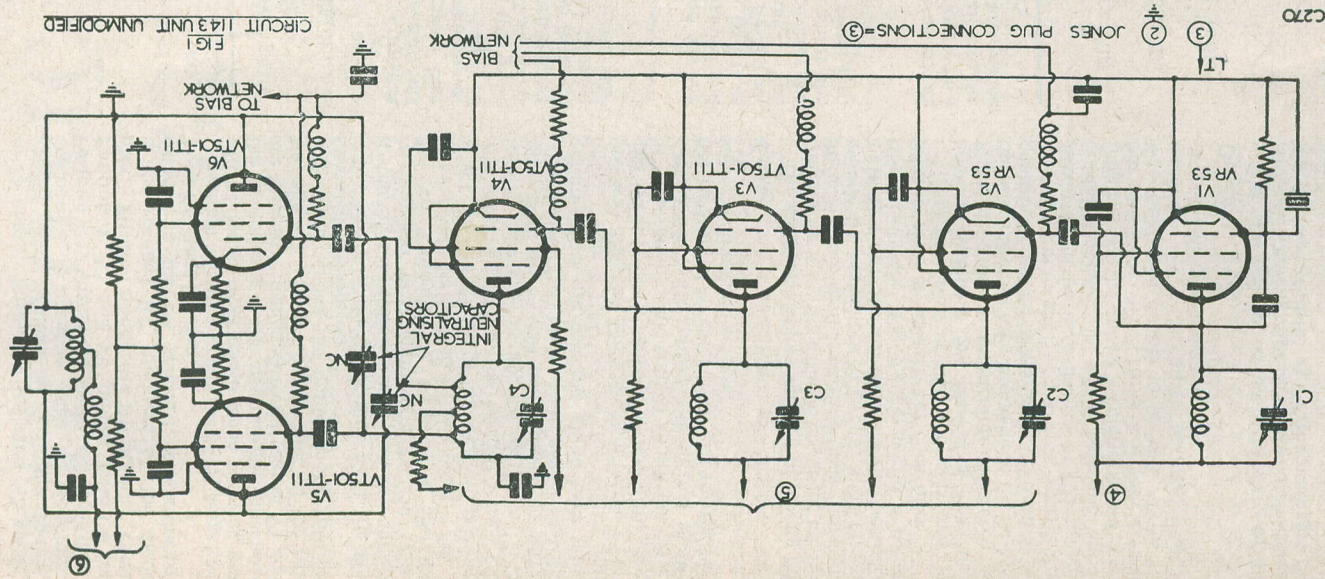

FIG. 3. MODIFYING OUTPUT COIL

6211 B

6275 A

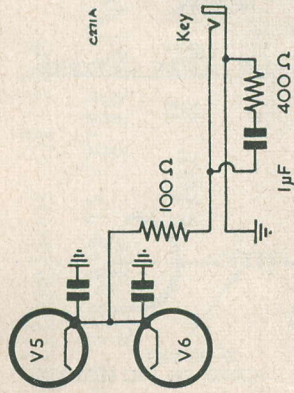

FIG. 5. CATHODE KEYING IN THE PA STAGE

the junction, taking care to leave the by-pass capacitor connected, and solder a lead to this connection, long enough to go to your bias supply. This will need to be in the neighbourhood of 60 volts, depending on the amount of drive you have available. Now disconnect the screen of V4, and insert an RF choke as detailed in Fig. 4. This is to guard against the RF losses which may occur due to series resonance of the screen circuit, and in most cases it effects an improvement in the RF output.

Tuning

The automatic tuning assembly on the top of the unit may be completely dismantled and standard $\frac{1}{4}$ " knobs fitted, or it may be left as found and, with all the cam rods pushed in, tuning may be carried out manually. The four crystal switch arms will be seen near the crystal holders; do not forget to short the appropriate contact to bring the crystal into circuit.

Meter Switch

The meter switch selects the various anode feeds etc., and is used in conjunction with a 1 mA meter connected to the small two-pin plug situated on the top of the case, and loaded

Many thanks to the numerous readers who so kindly sent us Christmas Greetings from home and abroad.

HARMONIC DRIVE

— Part Four —

By P. TURNER

IT is an easy thing to visualise a vector which varies its speed, so it comes in handy for explaining purposes. One of the easiest waveforms to imagine in this way of variable speed vectors (and the most difficult to deal with in practice) is our old enemy the 'square wave'. Look at Fig. 7. This shows a nearly square waveform, something like what you might expect in an actual circuit. The waveform has a peak value which is maintained for quite a long time, relative to one cycle. During this time the vector which is describing the wave must stand perfectly still at the ninety degrees position, or vertical, if you prefer to put it that way. Then it must change from the ninety degrees position to the two hundred and seventy degrees position in a very, very short space of time. This means that it has to accelerate to an extremely high speed indeed. This in turn means that the rate of change of current in the circuit which is producing the square wave must be very great indeed. So during the time in which the vector is changing to its upside-down position the circuit has all the attributes of a circuit which is oscillating at a very high frequency with a more ordinary waveform. During the time when the vector is standing still, however, there is no change in the current being described by the vector. This means that the circuit is not capable of driving anything at all during this time. All this adds up to the fact that it is capable of driving circuits which are tuned to frequencies many times higher than the fundamental.

It is possible to give two distinct types of distorted waveforms which have properties peculiar to themselves. Look at Fig. 7 'B'. Here is shown a square waveform and, on the same base line, the second harmonic frequency as a sine wave, which could be expected in a tuned circuit. It will be seen that the energy imparted to the coupled circuit at twice the fundamental frequency during one portion of the current swing is cancelled again during the next portion of the current swing. Now look a little further along. Here is shown the third

harmonic frequency. It will be seen that all the current swings of the circuit having the square waveform tend to reinforce the energy in a coupled circuit tuned to three times the fundamental frequency. Now look at Fig. 7 'C'. Here is shown a lop-sided triangular waveform, and on the same base line the second harmonic frequency. It will be seen that the cancellation of energy, as explained earlier, is not complete, and therefore a circuit having a rate of change of current shown by a similar lop-sided waveform such as this one may be expected to drive circuits tuned to even multiples of the fundamental frequency, while the current having a square waveform, or a waveform symmetrical about the horizontal axis, may be expected to drive circuits tuned

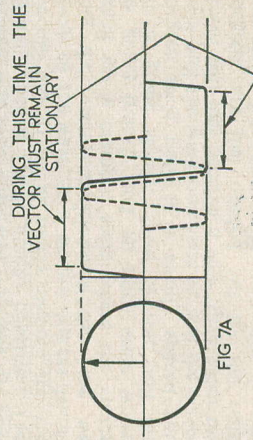

FIG 7A

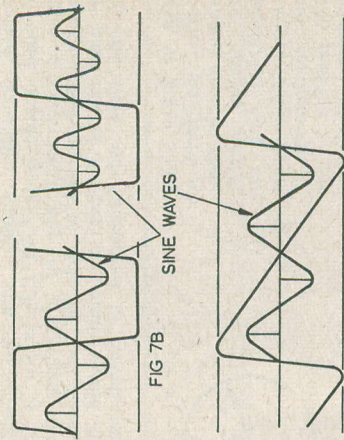

FIG 7B

FIG 7C

C522

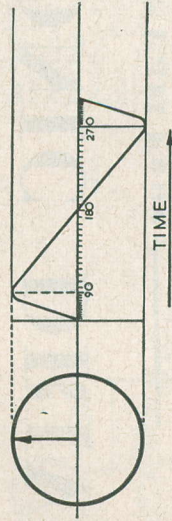

Fig. 8: The vector of Fig. 8 rotates, first, quickly through 90°, then slowly through 180°, then quickly again. This causes the vector degrees scale to be alternately cramped and open. As time is permanently evenly divided, this

C523

scale cannot be used for comparing "relative timing" or phase, as we say, of two waveforms.

to odd multiples of the fundamental frequency. This is only a very general statement, and it is more likely to find that both odd and even drive would be obtained from any current having a distorted waveform, unless special arrangements were made to exclude one or the other.

Why there are two Kinds of Degree Scales

Before we shove along any further, there is a little point which ought to be cleared up. You remember that we found out that if you plot the apparent height of a vector against its own position in degrees as it rotates, you will always get a sine wave. Look at Fig. 8. This shows a distorted waveform. Its peak voltage occurs quite a long way before the half way line between going positive and going negative. The vector has to be at ninety degrees for the peak of the wave, so if we put degrees denoting the vector position at the base we shall get a cramped scale where the vector is going quickly and an open scale where it is going slowly. Now if you pull the degree scale until it is evenly spaced you will pull the waveform with it, and the waveform will just become a sine wave when the degrees are just opened out by the right amount. Yet sometimes you see a distorted waveform shown with an evenly divided degree scale. All this is for is to give a convenient way of comparing the spacing with regard to time of two waves. It need not be degrees; any units would do if you were only interested in waveforms.

Fig. 9: When a distorted waveform is shown upon an evenly divided degree scale, as here, the degree scale bears no relationship to the position of the vectors, but is used only to decide the relative positions of the two waveforms, with respect to time.

C524

The use of degrees comes from sine wave study. Look at Fig. 9. This shows a distorted wave and an exact replica ninety degrees out of phase. The vectors would rotate as shown at the left. They would not be exactly ninety degrees apart all the time because they are varying in speed, but they would average ninety degrees apart.

Now look at Fig. 10. Here we have two sine waves ninety degrees out of phase. In this case, the changing quantity may be plotted against time or degrees rotation of the vector as the horizontal part of the graph, and the result is still a sine wave. So the same scale may be used for either purpose. The vectors will rotate at a steady speed ninety degrees apart all the time.

This brings us to another little point which is often missed, and the blame for this may be laid with Old Gaffer Sine Wave again. A valve cannot cause a "phase change" of 180 degrees, as it is commonly said to do. You will see that this is true if you look at Fig. 11 'A'. This shows a distorted wave and the same waveform 180 degrees out of phase. Now look at Fig. 11 'B'. This shows the same waveform as the input to a valve, and the output of the valve when its gain is about unity, as they say. The valve actually *inverts* the waveform, it does not cause a phase change at all. If the input to the valve is a sine wave, however, the inverted wave is exactly the same as if the waveform had suffered a true phase change of 180 degrees. This means that, when you are dealing with sine waves, neither

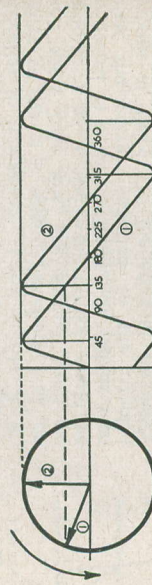
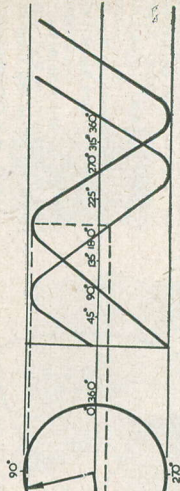

Fig. 10: Here are two sine waves 90° out of phase. The base scale is evenly divided in any case, and so may be used to refer to the position of the vectors or the relative timing of the two waveforms.



C525

you nor the valve can tell whether the wave has had its phase changed, or whether it has been inverted, so long as the phase change is exactly 180 degrees. Since most types of valve oscillators produce a waveform which is very nearly a sine wave, the inverted wave or the phase change may be used as desired when making calculations. This brings to my mind yet another point which caused me a good deal of unrest until I spotted the fallacy. In a push-pull amplifier, the input to the push-pull valves is always stated in this manner; the input to valve 'A' and the input to the valve 'B' must be 180 degrees out of phase. If this requirement were complied with, the amplifier would only be able to deal with perfectly symmetrical waveforms, such as a sine wave. If an ordinary audio waveform were fed to it, it would be anything but push-pulling. The stages in a push-

(To be continued)

pull amplifier which are called phase splitters or phase inverters are wrongly named, then. They should be called waveform inverters, for that is the function which they perform. Prior to realising this fact, I had attempted to follow the action of a push-pull amplifier and, of course, I fell straight into the trap. I imagined the audio inputs to the push-pull valves as stated, and consequently I was reduced to the necessity of ascribing magical powers beyond my feeble comprehension to the output transformer. When I found that phase does not enter into it, everything became crystal clear, and push-pull amplifiers, which had been a mighty mountain, shrank rapidly to the familiar soap-box size of 'Things We Understand'.

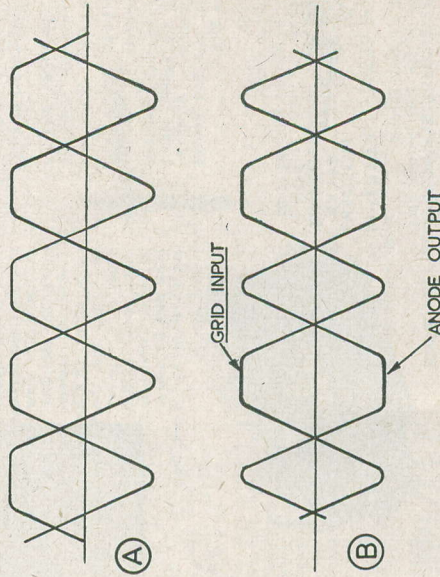

Fig. 11 (a): A distorted waveform and a replica 180° out of phase.

Fig. 11 (b): Grid input to a valve and the anode output, when the gain of the valve is unity.

C526

ELPREQ PAGES

BREAK-DOWN UNIT

At present day prices the spares for this unit would cost at least £5. Here is a list of the main contents:

- 3 two-metre coils;
- 3 tuning condensers, split-stator type;
- 4 two-watt carbon resistors, useful values;
- 1 tapped 20 watt resistor, vitreous covered;
- 6 paper condensers, .05 mf. 1,000 v. working;
- 3 paper condensers, .1 mf. 1,000 v. working;
- 2 H.F. chokes;
- 4 paper condensers, .1 mf. 450 v. working;
- 2 paper condensers, .15 mf.;
- 5 bakelite moulded mica condensers, .001;
- 1 paper condenser, .01 mf. 3,000 v. working;
- 24 rubber grommets, assorted sizes;
- 6 resistors 1 watt, all useful values;
- 6 resistors ½ watt, all useful values;
- 40 resistors ¼ watt, all useful values;
- 40 silver mica condensers assorted values, including: 10, 15, 20, 40, 50, 100, 150, 500, and 500 pt. types;
- 4 English octal valve holders;
- 2 English 5-pin valve holders;
- 3 E.P.30 type valve holder;
- 3 diode valve holders;
- 1 low-voltage casing, size 12 x 7 x 4in.
- 1 heavy metal chassis size 12 x 7 x 2in.;
- 8 condenser clips, assorted sizes.

Also an assortment of nuts, bolts, P.K., self-threading screws, tag boards, chassis mounting tag connectors, screened grid caps, plain grid caps, levers, rollers, connecting rods, output sockets, etc. ALL THIS COLLECTION OF PARTS FOR 6/6 only, plus 1/9 postage and packing.

SPECIAL RELAY

Hermetically sealed in glass angle shape and designed to operate in strong magnetic field, e.g., when near a magnetron. American made, new and unused price 27/6.

PLUGS FOR MODERN VALVE HOLDERS



Each is fitted with a rubber hood. Type 1 for 87G button base. Type 2 for B9A novel base. Price 1/4 each, discounts for quantities.

MAGNETIC T.V. TUBES

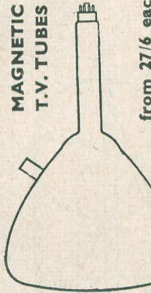

from 27/6 each.

All made by first grade firms, Brimar, Mazda, Mullard etc. They have been slightly used but will probably give years of service.

TYPE A. Only fault is low heater to cathode insulation. These will give perfect picture in grid modulated circuit—price £3, 15, 0 each, 12" price £5, 15, 0 each.

TYPE B. Have small ion burns but good cathode to heater insulation. Will be quite suitable in any type circuit—price £2, 15, 0 each, 12" price £3, 15, 0 each.

TYPE C. Have combination of both above faults, but will still give reasonably good picture. 9" price £1, 7, 6, 12" price £2, 15, 0 each.

NOTE. Callers to our Ruislip branch can see these tubes demonstrated, but whether you see it or not we guarantee a 'working' tube. If not calling, please add 7/6 each tube for packing and postage.

PROFESSIONAL RADIOSET YOU CAN MAKE

You will find that the all mains radio receivers is simplicity itself, and the more you make the less time each takes. Everything done to the last nut and bolt is supplied, and everything fits together in a professional manner.

When finished the receiver looks and plays as well as those being offered in radio shops at anything between £1 and £14, illustrated above we call 'The Occasional' in choice of colours, Ivory, Walnut or Green, and the T.R.F. costs just less than £6 to make while the superhet costs approximately £7.

The other radio illustrated is 'The White Lady', this is an extra fine cabinet of pure white. The complete T.R.F. set costs about £6/5/0 to build, and the superhet receiver costs about £9/5/0 to build. Constructional data for either set is available at 1/6 post free.

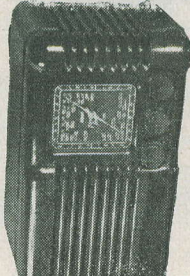

5 WAVEBAND 7 CHASSIS

A famous set by a famous manufacturer. Undoubtedly a serious listener's receiver, special features are H.F. stage and tuning indicator. It tunes up to 11 metre band. Price, new with all valves, but less speaker £14/19/6 Carriage and Packing 15/- partly returnable. A.C. mains and Car battery models available.

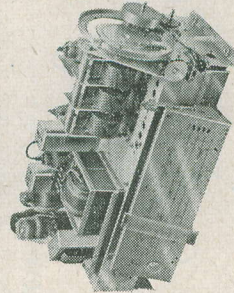

TRANSFORMER BARGAINS

All by famous makers such as Parmeko.

200 mA, 340-0-340 v. 6.3 v. at 4 amps, 5 v. at 4 amps, 4 v. at 3 amps, unshrouded but fully impregnated, a really first-class transformer. Price 25/-.

150 mA, 425-0-425 v. 6.3 v. at 3 amps, 6.3 v. at 6 amps, 5v. at 6 amps, 4 v. at 2 amps, 4 v. at 1 amp, Price 65/-.

150 mA, 350-0-350 v. 6.3 v. at 4 amps, centre tapped, 5 v. at 3 amps, fully shrouded upright mounting. Price 32/6.

80 mA, 350-0-350 v. 6.3 v. at 4 amps, 4 v. at 3 amps, half shrouded drop through. Price 19/6.

80 mA, 370-0-370 v. 6.3 v. at 4 amps, 5 v. at 3 amps, half shrouded drop through. Price 19/6.

70 mA, 230-0-230v. 6.3 v. at 3 amps, 4 v. at 2 amps, half shrouded upright mounting. Price 22/6.

60 mA, 260-0-260v. 6.3 v. at 3 amps, 4 v. at 2 amps, half shrouded drop through. Price 16/6.

60 mA, 260-0-260 v. 4 v. at 4 amps, 4 v. at 2 amps. Price 16/6.

40 mA, 250-0-250 v. 6.3 v. at 4 amps. Price 12/6.

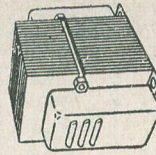
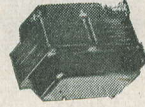

Really beautifully made transformers, fully shrouded upright mounting, with plated and polished shrouds.

TYPE 1. Primary 10-0-200, 220, 240, H.T. secondary 350-0-350v. at 250 mA, 4v. at 6 to 8 amps, and 4v. at 3 to 4amps. Dimensions are 4 1/2" x 4" x 4 1/2". Price 27/6 plus 2/6 postage and packing.

TYPE 2. Primary as Type 1, H.T. secondary 300-0-300 v. at 150 mA, L.T. 7.5-0-7.5v. at 3 amps, and 4v. at 3 to 4 amps. Dimensions are 4 1/2" high x 4" x 3 3/8". Price 17/6 plus 2/- postage and packing.

FILAMENT TRANSFORMERS

6.3v. at 1 to 1.5 amps, standard type for receivers, Price 6/6.

6.3v. at 1.5 to 2 amps, standard type. Price 8/3.

2v. at 2.5 amps, highly insulated for television, Price 7/6.

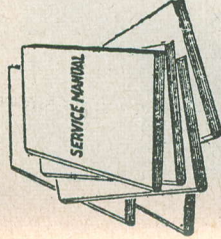

RADIO-GRAM CABINETS

Full size console type cabinets with highly polished walnut finish. Designed to take standard type auto change gram unit. You can have these at £12/10/0 each which means a really nice radio-gram for less than £30, for we can supply a 5-valve 3-waveband chassis at £10/10/0 (minor alterations to the radio chassis will, of course, be necessary). Gram units ordinary from £5/5/0 auto from £11/15/0. **Special Offer.** Cabinet complete with auto change unit and pickup £22/10/0.

3 WAVE-BAND 5-VALVE SUPERHET CHASSIS

Brand new, tested and ready for immediate operation, full vision scale size 6" x 8" covering the long wave 900-2,000 metres, medium wave 185-550 metres, and short wave 16-50 metres. Complete with valves guaranteed by our six months first class parts, Parmeko mains transformer, Erie resistors, Hunts condensers, etc. Special points include: (1) Flywheel tuning, (2) Dust-core I.F.'s, (3) Sockets for extension speaker and pick-up. (4) 4 watts output, (5) Coil assembly removable as a unit.

Price complete with 8" speaker £10, 10, 0. Carriage, packing and insurance 7/6 extra.

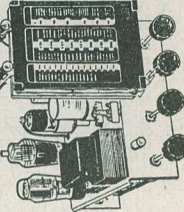

WARM YOUR HOUSE THE MODERN WAY MAKE A CONVECTION HEATER

Using Ex-Admiralty HEATING UNITS fitted with 3-pin brass plug and socket. Copper-clad enclosed elements are used and these again are enclosed in sheetmetal half cylindrical containers. Fit one of these into a metal cabinet, and you have an excellent convection heater. In places where appearance is not important, all you need extra is the wire, as the heaters work perfectly well as they are, without extra casing, the actual element being totally enclosed.

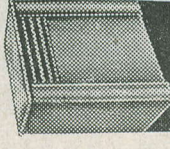

PRICES

2 K.W. 220/230 v. 12/-, 1K.W. 220/230 v. (Two elements used in series), 14/-, 500 W. 220/230 v. 12/-, Carriage 2/- extra, per heater. Sketches and details of suitable cabinet are supplied with each heater. 2 K.W. 110 v. heating units are also available at 7/6 each. These are ideal for greenhouse heating, or for space heating or foot warmers under benches, etc. Eight of these in series will consume 1 K.W. and will spread the heat out over a wide area.

Orders under £2 add 2/6, under £1 add 1/9. Postable items can be sent C.O.D. additional charge approx. 2/6. List 6d. Early closing, Wednesday—Ruislip, Saturday—City.

PRECISION EQUIPMENT

WINDMILL HILL, RUISLIP, MIDDLESEX.
152-153, FLEET STREET, E.C.4.

SPEMET

Made from polished aluminium, an excellent material for fronts of cabinets or for special cabinets you are making, and for air conditioners, etc.

Close mesh 8 holes to the inch. 24" x 12", 10", 12" x 12", 5/3, 6" x 6", 1/9.

Wide mesh 4 holes to the inch. 24" x 12", 9", 12" x 12", 4/9, 6" x 6", 1/6.

Postage and special packing 1/6 extra for any quantity up to 12 sheets. Over 12 sheets post free.

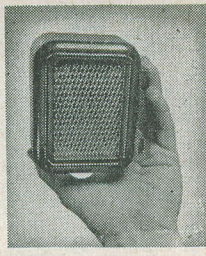
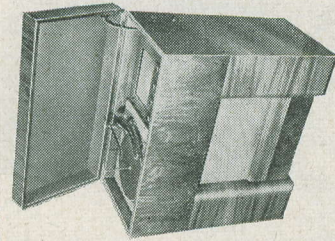

MIDGET EXTENSION SPEAKER

3 1/2" moving coil speaker in bakelite cabinet with metal grill and back fitted with terminals, size 4 1/2" x 4 1/2" x 2". Ideal as desk extension or for bedroom, kitchen etc., also makes good microphone. Price 18/6

UNIT TYPE RDFI

As suggested by 'Practical Television', October as suitable for a home built Televisor, but with the complete set of 14 valves instead of 11, e.g., 5 of SP61, 2 of P61, 3 of EA50 and 1 each of CV63, EB34, EC53, 5Z4. Price 49/6 plus 5/- post.

194 STRIP

Also described in October 'Practical Television', contains 8 valves and really does give superior results. Price 45/- plus 2/6 postage.

Orders by post are dealt with by our RUISLIP depot. To avoid delay address to—E.P.E. Ltd., Dept. 3, Windmill Hill, Ruislip, Middlesex

A SINGLE-VALVE SIGNAL GENERATOR

By A. W. WOOD, B.Sc.

See warnings:

RC DEC. 1952, p. 202

S. B. 594E

19. 14. 30

THE following signal generator has these advantages:—

1. Ease of construction.
2. Low cost (only one valve is used).
3. Good stability.
4. Internal or external AF modulation.
5. Ease of calibration. (This point is very important in home-built signal generators).

This instrument does not claim to be a precision instrument, and would hardly suffice for the transmitting amateur as a sub-standard instrument! However, it will prove indispensable to the average experimenter and anyone who does spare time servicing. The signal generator was built as the result of the purchase of a grey metal case divided into two by a wooden partition. The lower half is empty, but the upper half contained what seemed to have been a signal generator. It was fitted with a variable capacitor and slow-motion drive, a five-position switch with five coils grouped around it, and an output switch giving 6 positions of signal strength.

It is not proposed to describe the unit as it was, as it is not likely that many people would be able to purchase one of these units. The disadvantage also arises, when modifying ex-Service gear, of adding additional controls, so that anyone wishing to build a unit on these lines would be able to adopt refinements.

The design has proved to be very stable, and variation of the output control has no apparent effect on the frequency. This is due to the fact that the hexode portion of the triode-hexode frequency changer used (a 6K8) acts as a buffer stage. The coupling

is purely electronic, in the valve itself. AF modulation is applied to the signal grid of the hexode portion, and internal modulation can be simply applied by injecting 50 c/s from a potentiometer across the heater supply. The oscillator uses the Hartley circuit, the coils being centre tapped. Normally the Hartley coils are in the cathode of the valve, but as the valve is a multi-electrode type, this would lead to undesirable coupling. A warning must be given here, that due to the tuning capacitor being in the anode circuit, neither side of the capacitor must be earthed. All metal parts must be insulated from chassis by paxolin, and an insulated coupler used between the slow motion drive and the capacitor spindle. Apart from this, construction is simple and straightforward.

The beginner is strongly advised to buy all the resistors and capacitors new. There are so few needed that the cost will be small, and the success of the unit will be enhanced. Apart from the increase in reliability, the appearance is so much better when new parts are used than when old and dirty components, perhaps with shortened connecting leads, are employed.

The unit must be completely screened if reliable results are expected, as when lining up a receiver it is essential that the signal enters by the leads from the generator, and not by the stray field. On the writer's unit there was a fairly large stray field until the wooden partition in the centre was lined with aluminium sheeting. Therefore, if a suitable case can be obtained, build your generator into it. If not, and you have not the facilities for making your own chassis,

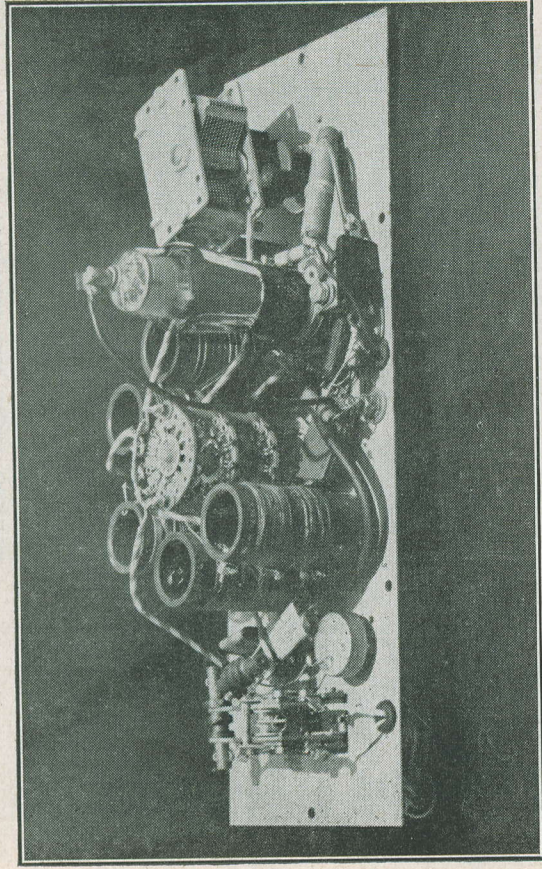

View of back of panel, showing layout of components.

Philpott of Loughborough specialises in making chassis and cabinets to individual specification.

The voltage on the triode anode is held constant by a neon regulator tube, which can either be in the signal generator itself, or in the power pack, if a separate power pack is used, an extra lead being then needed. Thus the only variations in frequency are caused by valve heating, and the stability of the coils and variable capacitor. Valve heating is catered for by switching on 15 minutes before the unit is required. Note that if ventilation holes are drilled in the case (and there are none in the writer's) they must be covered with fine gauze, to keep the screening complete.

The amount of trouble spent on the coils will depend on the accuracy to which the dial can be read. Obviously, if the dial is not fitted with a very low speed and vernier control, there is no object in spending a tremendous amount of care over the coils. Despite these remarks, the coils should be made rigidly, and all leads associated with the oscillator circuit should be short and direct, and made in heavy gauge wire (18 swg and upwards). If possible, the drive should be 100:1 and fitted with a vernier.

We now come to the most difficult part of constructing a home made signal generator, *i.e.*, the calibration. The course

normally advised is to feed the signal into a receiver together with the signal from a calibrated signal generator or from broadcast signals whose frequency is known. For the benefit of the beginner, it should be explained that when the frequencies of the two signal generators only differ slightly, an audio note will be heard. As the frequencies are brought into line, the frequency of the audio note decreases until there is a position where no signal can be heard. At this point the frequencies are exactly equal. The snag with this method is that a receiver covering all the frequencies needed may not be available, and especially at the same time as a calibrated signal generator. A method which dispenses with the need for a receiver is to mix the two frequencies in a multi-electrode valve and listen for zero-beat as before. Usually, however, this calls for an extra valve, and adds complications. Not so with this signal generator, as the 6K8 acts as a mixer. It is only necessary to inject the signal from the calibrated signal generator into the AF modulation grid.

Audio beats will then appear at the RF output sockets, and can be detected on a pair of headphones plugged into the output socket. The efficiency of this arrangement can be judged by the fact that when an indoor aerial was taken to the AF injection

Component List, Signal Generator

VR1, 250 k Ω pot.
 VR2, 500 Ω , value not critical.
 R1, 100 k Ω , $\frac{1}{2}$ W EriC.
 R2, 1 Meg Ω , $\frac{1}{2}$ W EriC.
 R3, 300 Ω , $\frac{1}{2}$ W EriC.
 R4, 50 k Ω , $\frac{1}{2}$ W EriC.
 R5, 68 k Ω , $\frac{1}{2}$ W EriC.
 *VC1, 500 pF var. air spaced, ceramic insulation.

C1, 0.005 μ F, mica.
 C2, 0.01 μ F, mica.
 C3, 0.01 μ F, mica with tags (Dubilier).
 C4, 0.002 μ F, mica.
 C5, 0.01 μ F, paper 450V wkg.
 C6, 0.01 μ F, mica with tags, (Dubilier).
 C7, 0.002 μ F, mica.
 C8, 0.01 μ F, mica.
 C9, 50 pF, silver mica.
 S1, 2 pole on/off toggle.
 S2, 1 pole 2-way toggle.
 S3, 4, 2 pole 4-way.

RFC, 1, 2, Standard RF choke.
 RFC3, 50 turns 20 swg enam. on $\frac{1}{2}$ " diam.

former, $2\frac{1}{2}$ " long, or any similar choke.
 One, ceramic IO holder.
 One, 6K8, or G or GT/G.

Four, paxolin coil formers, 3" long \times 1 $\frac{1}{4}$ " dia.
 One, co-axial output socket to take $\frac{1}{4}$ " cable.
 Two, co-axial plugs, RF output and phones.
 Two, bakelite screw terminals, red (modulation) and black (earth). Belling Lee.
 Insulated flexible coupler, Eddystone.

* If the interest of the constructor is mainly in short waves, this should be reduced to 100 pF, although the coverage on each range will be reduced.

Component List, Miniature Power Pack

T1, miniature bell transformer, output 0-5-8V.
 R1, 1 k Ω 2W, or midget LF choke.
 C1, 2, 16 + 16 μ F, 350V wkg.
 R2, see text.
 Selenium or metal rectifier, 250V 30 mA.
 One, VS110 or similar regulator valve.
 One, holder to suit regulator.

socket, and the signal generator tuned to 200 kcs, the audio beats could be plainly heard on a pair of high impedance phones across the RF output socket.

If a calibrated signal generator is not available, a 100 kcs crystal oscillator can be used to provide marker points, although, in this case, more care will be needed in guarding against choosing the wrong harmonic. Three RF Chokes are used to confine the RF inside the cabinet, otherwise there would be stray fields from the power supply leads.

The generator provides a good second harmonic signal, which is valuable for frequencies which are not covered on fundamentals. Losses will be reduced if the valveholder and, if possible, the waveband change switch are made of ceramic.

When the signal generator has been calibrated, calibration graphs should be drawn on graph paper, which is then pasted on to strong card and covered with cellophane. The larger the scale used, the better. For the not-so-experienced constructor, the calibration and use of the signal generator is given in greater detail.

Calibration

First of all, to find if the unit is working, switch to Range 1, turn the tuning capacitor until it is nearly at maximum capacity and switch on the heater current. Insert a co-axial plug into the RF output socket and feed the other end of the cable via a 5 pF

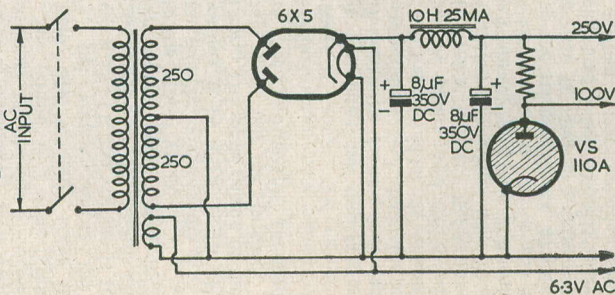
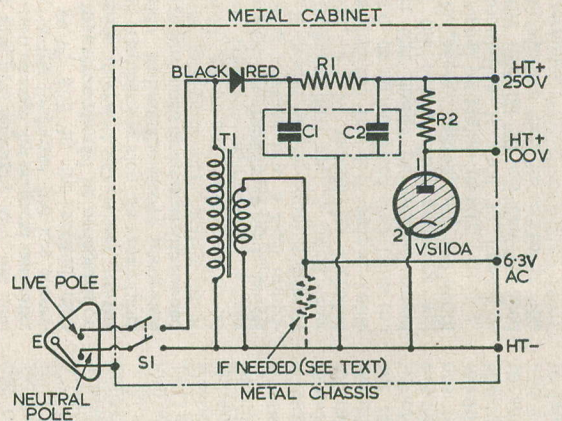
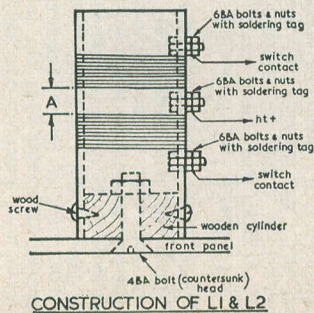
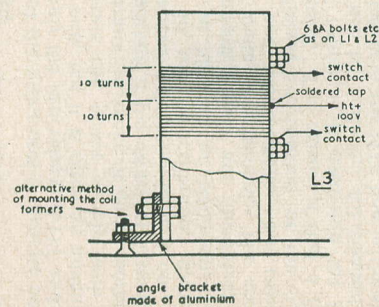
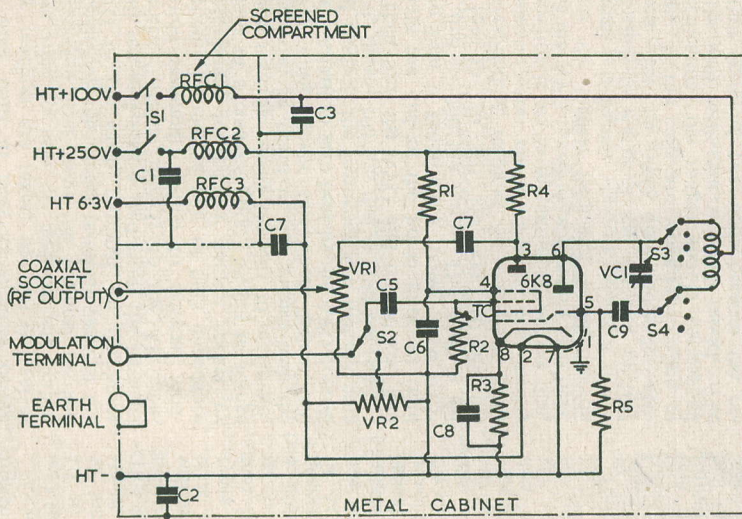

C534

on both units at least 15 minutes before any readings are taken, so that the valves have time to heat up and become stable. Connect a lead from the terminal marked "Earth" on the rubber terminal piece of the AVO to the earth terminal on the home built set, and take a lead from the terminal marked "Aerial" directly to the AF modulation terminal. Switch to external modulation. Connect a pair of high impedance headphones to the RF output socket by means of a co-axial plug. Switch to Range 1 and turn the tuning capacitor to maximum. Beats will be heard in the phones with the AVO tuned down somewhere below 200 kc. Adjust to zero beat by the AVO control and read off the frequency and make a note of it, thus:—100° on dial = 190 kc (say).

Then turn the AVO dial to 200 kc, and rotate the dial of the home built set until zero beat is found once more. Now 93.5° on dial = 200 kc (say). The AVO is set in turn to 250, 300, 350, 400, 450, and the corresponding readings on the home built generator are noted. Finally the tuning capacitor is set to minimum, 0° on the dial, and the AVO tuned once more to zero beat. Thus the highest frequency obtainable on Range 1 is found.

Switch to Range 2 and set dial at 100° again. Set the AVO once more for zero beat. If the coils are wound according to specification, the ranges should correspond fairly well with the original model. The author rewound two coils because the originals were not neat enough, and the dial settings did not change by a great amount; for example, in the first case 200 kc corresponded to 89.5°, and in the second case to 93.5°, so that there should be no confusion with harmonics if the AVO is set to the approximate frequency given in the table for each band. Follow the above procedure for each range and draw graphs as mentioned before.

Operation

Output is at high impedance and, unless the generator is working into a high impedance circuit, it should not be coupled directly to the circuit being lined up. A small value capacitor, say, 5 pF, should be included between the end of the RF output cable and the probe, or an insulated wire from the circuit under test should be coupled round the end of the cable. This coupling will transfer all the energy needed, and will avoid loading the signal generator heavily.

If the modulation is used to line-up a set, either the internal 50 c/s can be used or any audio source can be taken to the modulation terminal.

Power supply

At present the writer uses a separate power unit to supply the two values of HT and the LT to the unit, but it is often an advantage to incorporate the power supply with the signal generator to make it more portable. This is important if the owner of a standard frequency source refuses to loan it out, but will allow its use for calibration provided it is done at his own establishment. Two types of power supply are illustrated, the first being quite conventional. The second is cheaper and much smaller, but requires a little different construction of the signal generator itself. The reason is that a form of AC/DC technique is used and the HT-line *must not* be earthed. All connections which are taken to the HT-line in the theoretical diagram are insulated from earth by paxolin, and the HT-line is connected to the metal cabinet by a 0.01 μ F mica capacitor, thus earthing the HT-line to RF. An extra precaution is to fit a non-reversible plug to the AC mains power lead, and arrange that the neutral pole is connected to the HT-line; this means that practically no voltage exists between the HT-line and earth.

Only 4 components are needed for this miniature power pack, and these are illustrated in the cover photograph, with a match box to show the relative size. The transformer deserves comment. It is a miniature bell transformer bought for 5/- from Woolworths. The output is 8 volts tapped at 5, but on load, with 0.3 amp taken from the secondary, the voltage across the heater is just over 6.3V. If the voltage is too high, a 100 ohms resistor or thereabouts connected across the heater supply will reduce the voltage to the proper value.

A metal rectifier converts the AC to DC, and smoothing is by a 16 + 16 μ F, and a 1k Ω resistor. The metal casing of the double electrolytic must not be earthed, and is shown in the photograph clamped to a paxolin panel.

Construction

This is simplified by the fact that no chassis is used, the front panel supporting all the components, and the valve is horizontal. The valve holder is mounted off the chassis by pillars, and C6 is positioned under the valve holder. Before the valve holder is bolted into place, C6, C3 and C2 are bolted down, and the following connections are made to the pins. 100 k Ω resistor to the screen (pin 4), 47 k Ω resistor to anode (pin 3). Pin 1 is joined to pin 7 and a flying lead is left, about 2" long, which is later earthed. The cathode resistor and

Coil Details

Coil	Turns each side of CT.	How wound	Wire	Approx. freq. coverage with 500 pF condnsr.
L1	130 A = $\frac{3}{8}$ "	In three layers $\frac{3}{8}$ " width each side of CT. Close wound.	33 swg enam. & single rayon covered.	198-486 kcs
L2	60 A = $\frac{3}{8}$ "	Single layer $\frac{3}{8}$ " each side of CT. Close wound.	33 swg enam. & single rayon covered.	420-1880 kcs
L3	10 A = 0 (no spacing)	Single layer spaced to fill $\frac{3}{8}$ " each side of CT.	25 swg enamelled.	2.17-10.67 mcs
L4	24 A = 0 (no spacing)	Single layer spaced to fill $\frac{3}{8}$ " total.	20 swg tinned copper.	7-35 mcs

If different size coil formers and wire gauges are used, the ranges covered will vary to those given above. To tune lower in frequency, add turns, and to tune higher remove turns, until the required range is covered.

bypass capacitor are fastened to pin 8. Flying leads are taken from pins 5 and 2, and suitably bent 18 swg wire is soldered to pin 6. Now the valve holder can be bolted into place. Take care when shaping the heavy gauge wire that no strain is imposed on the valve holder tag—otherwise it may break off. The writer gives this warning in the light of bitter experience! Methods of mounting the coils etc., are given in the accompanying sketches. The front panel should be very rigid, and can be in one flat piece if it is about 12 swg or 14 swg aluminium. If it is 16 swg aluminium, the edges should be turned at right angles, to provide additional strength. The cabinet enclosing the generator can be made of 20 swg aluminium. There is an unused wafer on the wavechange switch, and this is used as an anchoring place for the coil centre taps. All the tags were then bonded by heavy gauge wire, and taken to the HT switch via an RF choke. If there are no spare tags, a large sized soldering tag should be bolted to a paxolin strip which in turn is bolted to one of the bolts securing the switch wafers, and all the centre taps are soldered to this large tag. Note that the bypass capacitor C1 is connected on the power supply side of RFC2 so that the RF choke helps to divert more of the RF into the output socket. If a separate power pack is used, the leads should be brought out of the cabinet as close as possible to the points where the RF is decoupled, to prevent RF radiation. If a different type of stabiliser

valve is used, the value of the dropping resistor may have to be changed.

The following formula will assist in obtaining the correct value. It is not quite correct theoretically, but is sufficient for practical purposes. Maximum value of dropping resistor =

$$\text{HT voltage} - \text{Voltage of stabiliser (100 or thereabouts)}$$

$$\frac{\text{Min. current of stabiliser} + \text{anode current of triode}}{\text{HT} - \text{stabiliser volts}}$$

$$\frac{\text{Max. current} + \text{anode current of stabiliser}}{\text{of triode}}$$

Naturally, in the interests of heat dissipation, the value chosen should be near the maximum. It should not be too high, however, or the stabiliser valve will not have sufficient volts across it, initially, for it to strike. The dropping resistor should be of ample wattage rating, found by multiplying the voltage dropped across it, by the total current passing through it:

Example:

$$\text{HT volts} = 250\text{V} \quad \text{Stabiliser volts} = 100\text{V}$$

$$\text{Min. stabiliser current} = 5 \text{ mA.} \quad \text{Anode current} = 3 \text{ mA.}$$

$$R = \frac{250 - 100}{5 + 3} = \frac{150}{8} = 18.75 \text{ k}\Omega \text{ approx.}$$

$$\frac{150 \times 8}{1000} = \frac{1200}{1000} = 1.2 \text{ watts.}$$

A 5 watt resistor should be used.

In conclusion, the writer can recommend this design to anyone needing a cheap and reliable signal generator.

Loudspeaker Baffles and Enclosures

PART 4

By J. R. DAVIES

High Frequency Radiation

WE have already, in the first article of this series, treated the radiation of the high frequency content of the reproduced sound in a theoretical manner. Let us now see how the theory may be put into practice.

As was mentioned earlier, the main methods of diffusing the higher frequencies are by means of horns, reflectors or a combination of the two. We also stated that, so far as the home constructor was concerned, the simplest method of radiating the higher frequencies over a wide angle was by the use of reflectors, with perhaps a simple horn to guide the sound to the reflector.

A very simple type of diffuser is shown in Fig. 13 (a) and (b). It will be seen that it consists simply of vertical slats fitted to

the front of the speaker enclosure, their purpose being to diffuse the top frequencies horizontally over a fairly wide angle. In practice, the slats could be made of wood, their width being about three to six inches. Apart from acting as reflectors, the slats form an elementary type of horn which also assists in ensuring a wide angle of radiation. The slats, however, possess the disadvantage that the diffusion given by them is uneven, and they are not therefore of much use for really serious work.

The Complete Enclosure

Let us now see how the problem of designing the complete enclosure has been tackled by commercial manufacturers.

An excellent illustration of design is offered by the Corner Loudspeaker made by Voigt Patents Ltd. A cross-section through the cabinet of this reproducer is shown in Fig. 14.

Looking at the diagram it may be seen that two separate paths exist for the low and high frequencies. The low frequencies (obtained from the back of the speaker) are dealt with in the bass chamber; being finally radiated from the lower part of the instrument.

The middle and higher frequencies are radiated by means of a horn combined with a distributing reflector. It is interesting to note the heavy materials which have been used for the reflectors, these being fitted not only to provide a smooth surface, but also one that is not liable to offer any unwanted resonances.

The curve used for the horn in this particular case is not exponential but follows what is known as the "Tratrix Curve". It is contended that a horn based on an exponential curve does not allow correct treatment of the sound waves at its mouth owing to the fact that this curve relies on the assumption that the sound from the loudspeaker has a plane wave front, whereas the

wave front at the mouth may be hemispherical at low frequencies. In the throat of the horn, nevertheless, the Tratrix curve is very similar to the exponential curve, and departs from it mainly at the mouth.

Materials for Construction

Apart from the design of the baffle or enclosure itself, it is also very important to ensure that the materials used in its construction do not detract from its final performance.

Wood is the best material in most cases, owing to the fact that it is easily handled and, if sufficiently thick, is not liable to resonate. Plywood cannot always be recommended owing to the fact that the laminations may come apart internally and so cause rattles or resonances.

Any joints which are necessary should be well made; and if glue is used, it should be applied liberally. Mountings, whether ornamental or part of the internal design (such as speaker transformers, cable cleats, etc.) should be screwed down as firmly as possible. If a fabric is fitted over the speaker opening this should have a coarse open mesh as, otherwise, it will attenuate the top frequencies.

Modern Developments

Before concluding this series of articles, it might be worth while examining some of the more modern developments which have been incorporated in reproducer design.

One of the most interesting of these is given by the Corner Ribbon Loudspeaker, made by the Acoustical Manufacturing Co., Ltd. Fig. 15 shows the external appearance of this loudspeaker whilst Fig. 16 shows its internal construction.

It will be seen from Fig. 16 that the back radiation of the lower loudspeaker feeds into a two-stage acoustic filter; this being designed to extend its bass response. The lower speaker handles the frequencies which fall below 2,000 c/s.

Above this frequency a horn-loaded ribbon unit comes into use. The horn is housed in the inverted L-shaped section at the top of the cabinet (see Fig. 15). The radiation from the horn is dispensed horizontally and vertically over a wide angle, not only forwards but also upwards and backwards against the corner walls of the room in which it is installed.

Apart from the very wide frequency range offered by this instrument, one of the most interesting points in its design lies in this wide angle radiation of the higher frequencies. Owing to the reflection offered by the corner walls behind the speaker, the apparent

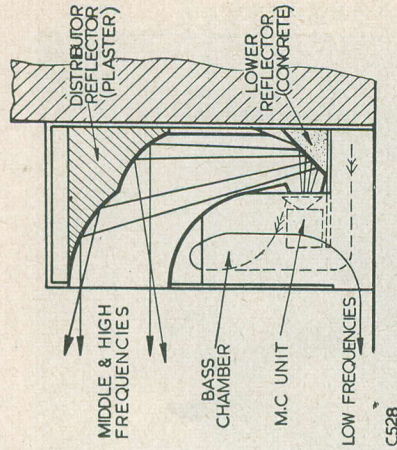
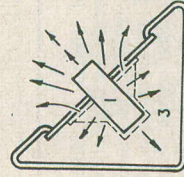
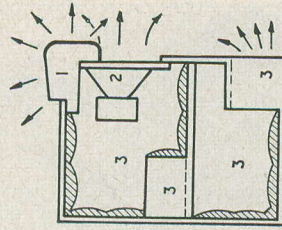

Fig. 14: The Voigt Corner Loudspeaker. (Reproduced by courtesy of Voigt Patents Ltd.).



C530

Fig. 16: The internal construction of the Corner Ribbon Loudspeaker. (Reproduced by courtesy of the Acoustical Mfg. Co., Ltd.).

Key:—

- (1) Multi-Directional Ribbon Unit.
- (2) Low Frequency Unit.
- (3) Elements of Acoustic Filter.

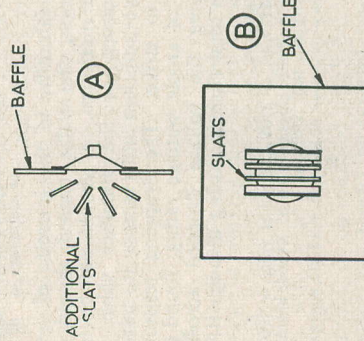

C527

Fig. 13 (a): Cross-section illustrating how slats may be fitted to a baffle to increase horizontal radiation of the high frequencies.

Fig. 13 (b): Front view of the slats.

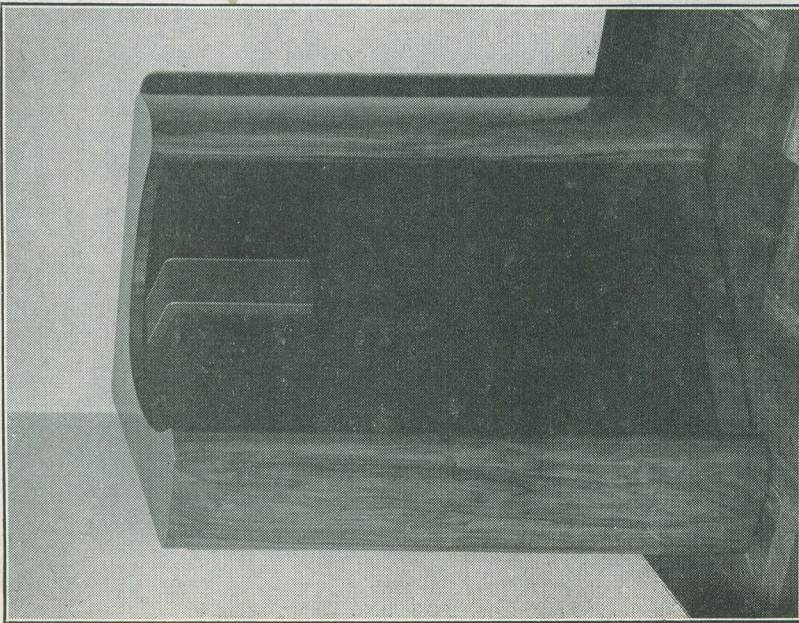

Fig. 15: The Corner Ribbon Loudspeaker. (Reproduced by courtesy of the Acoustical Mfg. Co., Ltd.).

source of sound is enlarged considerably, and the result is extremely effective in enhancing the realism of such programmes as orchestral music where the original sound does not itself come from a single point. On speech, the lower loudspeaker predominates and gives the effect of a source situated at one point only, such as would naturally occur if the person speaking were actually in the room.

This loudspeaker is of importance here because it goes one stage further in the field of offering realistic reproduction. Not only is it designed to give the best possible reproduction of the AF signals fed to it, but it is also intended to simulate those conditions which actually exist at the microphone itself. Whereas the source of sound from the usual

loudspeaker occupies only a fairly small area, this reproduction offers an apparent source which is very large, thus imitating the impression received in the concert hall itself.

Conclusion

We have now reached the end of this short series of articles which, it is hoped, have assisted the constructor; and which have perhaps given him some ideas for the design of his own baffle or enclosure.

The writer would also like to offer thanks to the following firms who so generously assisted him in preparing his material. These are: H. A. Hartley Co., Ltd., London, Voigt Patents Ltd., London, and the Acoustical Manufacturing Co., Ltd., Huntingdon.

QUERY CORNER

A "Radio Constructor" Service for Readers

A 9 kcs Whistle Filter

Some six months ago I completed a quality amplifier and tuning unit. The latter is of the superhet type using IF transformers which have a bandwidth of ± 8 kcs. During the day the combination operates very satisfactorily, but after dark, when the Continental stations come in on the medium wave band, I find it impossible to eliminate a high pitched whistle from the local station. Can such a whistle be satisfactorily filtered out without seriously affecting the quality of reproduction? If so, would you please recommend a suitable filter and give me some idea as to where it should be connected?

D. Scott, Lincoln.

It is most unfortunate that, when designing a quality receiver or tuning unit, a compromise has to be made when deciding upon the pass bandwidth. In order that the highest frequency response might be obtained, the bandwidth of the RF and IF stages in the receiver should be wider than 16 kcs. However, over the majority of the waveband the spacing between station is 10 kcs, and although stations which have similar frequencies are normally geographically situated far apart, interference can occur when propagation conditions are good. It will be remembered that due to changes which occur after dark, in the upper ionised

layers which surround the earth, long range medium wave reception is vastly improved. Under such conditions, a receiver having a wide bandwidth will accept two or sometimes three signals on adjacent carrier frequencies, with a result that a 9 or 10 kcs beat whistle will be heard. The only cures are to reduce the receiver bandwidth, or to employ a whistle filter. Some receivers are fitted with IF transformers which have provision for adjusting the pass bandwidth, in which case it is a simple matter to avoid the interference whilst at the same time slightly degrading the receiver response. Variable bandwidth IF transformers are manufactured by some component firms, but if these are used it is essential that the receiver is aligned with the aid of a good signal generator. Unless the transformers are correctly tuned a flat topped response curve will not be obtained, and much of their advantage will be lost.

An alternative method of eliminating a beat whistle is to employ a tuned filter in the audio side of the receiver. Such a filter must be capable of sharply reducing the receiver response only at the frequency of the unwanted whistle, otherwise the frequency response of the amplifier will be seriously impaired. A simple rejector circuit in the AF side of the receiver is hardly adequate

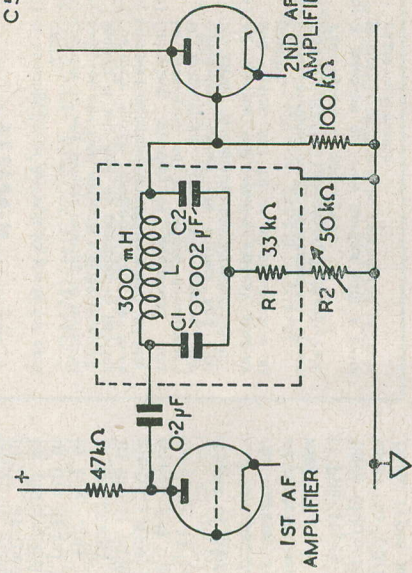

Fig. 1. Circuit of a 9 kcs. Whistle Filter.

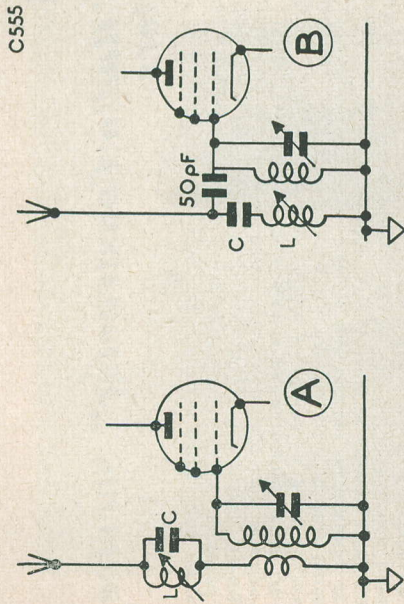

Fig. 2. Series and parallel types IF filters.

as a whistle suppressor. This is because of the difficulty in obtaining a sharp cut-off due to the damping imposed on the filter by the anode load of the previous valve, and the input impedance of the following stage. It is therefore necessary to resort to a filter of the type shown in Fig. 1. This arrangement is capable of providing a sharp cut-off at the unwanted frequency of over 40 dB. The filter may be conveniently connected between the first and second audio stages of the receiver, or between the tuning unit and the amplifier, if this latter arrangement is used. The filter should be roughly

tuned to the interfering frequency by adjusting either the inductor L or the two capacitors C1 and C2. These capacitors may consist partly of preset trimmers of the type normally used as oscillator padders in superhet receivers; both must be adjusted in step if optimum results are to be obtained. The inductor will be very susceptible to induced voltages from stray magnetic fields, and for this reason it is advisable to enclose the complete filter within an earthed metal screening compartment. Once the filter has been tuned, the variable resistor R2 should be adjusted for optimum results. In tuning AF filters a variable frequency audio oscillator will be found of immense assistance.

Another cause of whistles in high quality receivers is a beat between the IF signal and an unwanted signal on a frequency which is adjacent to the intermediate frequency. This form of interference is normally termed 'IF breakthrough' and can be eliminated by including a rejector circuit in the aerial lead to the receiver as indicated in Fig. 2(a). Fig. 2(b) shows an alternative arrangement using a series tuned circuit. In either case, the trap is tuned to the intermediate frequency of the receiver, the components 'L' and 'C' being conveniently taken from an IF transformer of suitable frequency.

Types of Microphone

I am puzzled as to the specialised uses of the various types of microphones which are at present available. Can you please enlighten me?

K. Albert, Portsmouth.
The types of microphone in current use have characteristics which suit them individually to particular applications. The three basic types are as follows:—

FIRST-CLASS TELEVISION and RADIO COURSES . . .

GET A CERTIFICATE!

After brief, intensely interesting study—undertaken at home in your spare time—**YOU** can secure your professional qualification or learn Servicing and Theory. Let us show you how!

-----**FREE GUIDE**-----
The New Free Guide contains 132 pages of information of the greatest importance to those seeking such success compelling qualifications as

A.M.Brit.I.R.E. City and Guilds Final Radio, P.M.G. Radio 'Amateurs' Exams, Gen. Cert. of Educ., London B.Sc. (Eng.), A.M.I.P.E., A.M.I. Mech. E., Draughtsmanship (all branches), etc., together with particulars of our remarkable Guarantee of

SUCCESS OR NO FEE

Write now for your copy of this invaluable publication. *It may well prove to be the turning point in your career.*

FOUNDED 1885—OVER

150,000 SUCCESSSES.....
NATIONAL INSTITUTE OF ENGINEERING
(Dept. 469), 143, HOLBORN, LONDON E.C.1.

WEST END RADIO LTD.

"The best in the West"—for Ex-Govt. Bargains.

Always in stock:—

No. 38 Walkie-Talkie chassis, partly stripped, in case, no valves. 5/11. Postage 1/0.

WANT A REAL

COMMUNICATION RECEIVER?

The CRI100, Ex-Navy, 11 valve job, 6 wave bands with built in power pack. Send 6d. for pictures. The price?—£29 10 0.

Brand new 1355 units. Type 74 Test sets. 150 different types of Ex-Govt. valves and meters. HUNDREDS OF BARGAINS FOR CALLERS.

WEST END RADIO LTD.

14, Lisle Street, Leicester Square, London, W.C.2.

Phone: GER 7341. Open all day Saturday.

1. Dynamic type. This heading covers all moving coil microphones which are normally of the low impedance type and consequently require matching transformers. A good frequency response and a robust construction are characteristics of these units. Close talking does not usually cause blasting or boominess. A good all round microphone for the reproduction of speech and music.

2. Velocity or Ribbon type. These are sensitive microphones suited for the pick-up of speech, music and singing, especially by artists in stage plays. The output impedance is low and a matching transformer is required.

3. Crystal types. These small, robust microphones have a high voltage output at a high impedance making a matching transformer unnecessary. These characteristics render the crystal units particularly suitable for use in PA equipment, where the frequency response of from 60 to about 8000 cycles is more than adequate. The reduced low frequency response is in fact an advantage in most PA installations, where it reduces the boominess of the installation making speech reproduction more easily understandable.

Other types not in general use include the condenser and carbon microphones. The condenser microphones have a very small output and require a high gain pre-amplifier, this latter introducing difficulties which have helped to render the type obsolete. The carbon microphone requires a power source for polarising the carbon granules, and is now only used with amplifiers having a relatively low gain. Carbon microphones have now been superseded largely by those employing crystal insets.

Solder

I have noticed that various types of solder are available; presumably they are intended for different classes of work. If this is so, which type is recommended for making solder connections in electronic equipment?

D. Fraser, Brighton.

Our correspondent is, of course, correct in assuming that different solders are manufactured for different jobs. The various types differ largely in the ratio of tin to lead which they contain. For normal radio or television receiver wiring a solder having a tin to lead ratio of 60/40 is recommended, and for the best results one having a resin flux core should be selected. The diameter of the flux cored solders is classified according to the standard wire gauge table, the most convenient size for general purpose working being 16 swg.

QUERY CORNER

“Rules”

- (1) A nominal fee of 2/- will be made for each query.
- (2) Queries on any subject relating to technical radio or electrical matters will be accepted, though it will not be possible to provide complete circuit diagrams for the more complex receivers, transmitters and the like.
- (3) Complete circuits of equipment may be submitted to us before construction is commenced. This will ensure that component values are correct and that the circuit is theoretically sound.
- (4) All queries will receive critical scrutiny and replies will be as comprehensive as possible.
- (5) Correspondence to be addressed to “Query Corner,” Radio Constructor, 57 Maids Vale, Paddington, London, W.9.
- (6) A selection of those queries with a more general interest will be reproduced in these pages each month.

Radio Miscellany

THE account of an ISWL member's holiday in Germany in last month's Short Wave News, reminds me that despite the international aspects of our hobby fewer holidays of this sort are arranged than might be expected. Such a holiday is an ideal way of getting to really know something of the way of life in other countries. You learn far more about the people, family life, their shopping and shortages, radio programme tastes and everything else in a few days, than you can from months of hotel life. There is great fun, too, in getting to meet the friends of the family, particularly those who are radio-minded.

I have spent several holidays in this way and I hope to have many more equally enjoyable. My two favourite countries are Holland and Denmark. Perhaps I feel an imagined affinity with the Dutch and the Danes. Not that they are alike by any means. The Danes are gayer and more responsive. Perhaps the thing that most impresses the English visitor is the way they give themselves over to light-hearted (and spirited) fun with a complete absence of rowdiness. A visit to Copenhagen's Tivoli Gardens is a revelation to new visitors.

Denmark has the most attractive girls, but in radio interest Holland has a good lead. There you will find a tremendous interest in constructional radio, with one of the highest concentrations of transmitting amateurs in the world. The country's biggest industrial concern is centred on radio and electronics, which probably adds to their radio consciousness.

Incidentally, amateur and constructional radio seems more closely allied there than in England. The vast majority of amateur transmitting and receiving equipment in the PAØ stations is home-built—not always from choice, as factory made equipment and communications receivers are dear and scarce. Nowhere else in post-war years have I seen so high a general level of constructional work neatly carried out on clean lines, often with substitute materials. It is quite equal to England in the years prior to the last war, when the home construction of transmitters and short-wave receivers was in its heyday. An abundance of ex-W.D. and mass produced communications receivers has blunted much of the best constructional work here since the War. The keen observer will also be fascinated at the cunningly contrived aerials to be found on the tall narrow houses of the bigger towns

—but you have to get up to roof level to see them.

BITZAS.

When both countries were occupied by the Germans during the war, many domestic sets were confiscated and most efficient receivers were built behind curtained windows so they might still listen to the BBC. Some of these were still retained for sentimental reasons, and they are made out of all sorts of unlikely things. Bitza everything, so to speak—hence the name I use to describe them. I first heard it applied to mongrel motor-bikes, but it is more truly descriptive of those receivers. The hiding places are equally ingenious; the most popular seemed to be under a loose floor-board in the lavatory!

Even to-day, in many receivers you find a delightful diversity of odds and ends with many truly cosmopolitan sets using Dutch, German, American, British and even a few odd Russian valves and components.

Getting back to holidays, I have stayed with comparatively well-off and comparatively poorly-off families with equal enjoyment. With another British amateur I once spent a few days with friends who made us most welcome in their tiny flat—plus a shack in the attic. Most of the older Dutch houses seem to have attics, with pulleys fitted outside to hoist things to the upper floors. Many of these attics are highly esteemed where no other accommodation exists for use as radio dens. They are mighty cold in the winter, especially with coal the price it is over there. These particular friends made us most welcome and went to a lot of trouble to ensure we enjoyed our stay, and when we left gave us little presents. It wasn't until afterwards that we learned they were in straightened circumstances at the time—a fact they had obviously been at some pains to conceal from us!

In Holland this year I made a special point of seeing something of their TV, both —two one-and-a-half hour spells per week) and from the lower powered station at Eindhoven owned by Philips. It was reliably estimated (no special licences were required) that there were less than 4,000 receivers, a thousand of which, at least, were home constructed. As for the programmes—the less said the better.

Readers who may be contemplating a holiday abroad next year cannot, from my experience, do better than make the Netherlands or

Denmark their first choice. There is no language difficulty, unless of course, you insist on talking Dutch or Danish to them, when they will never understand you, or else you try to do it in German when, even in the border towns, they will pretend they don't. If you don't know any families in the country of your choice, or have no friends to introduce you, the ISWL Holiday Exchange Bureau may be able to help you out.

Still Climbing

The rebuke to a certain Editor in the November Editorial of the RSGB "Bulletin" would seem to carry ample justification from the Society's viewpoint, but playing up the "commercial interests", angle, to my mind, is a mistake. Without concerning ourselves with the nature of the "interests" behind the magazine concerned, a fair review of publications given over to technical or hobby interest, will show that a great many of them are not run by Boards of Directors and Shareholders actuated solely by the profit motive. Nor are they run by big publishing houses. On the contrary, many are owned and managed by two or three enthusiasts who derive an income little, if any, in excess of what they would get elsewhere. They would certainly not then be bothered with so much responsibility nor have to work so hard. Generally speaking, too, they would be better off in the way of holidays, pension schemes and other privileges. While it would be absurd to pretend they are doing it for love, they certainly would not last long if they had no real enthusiasm for the job.

Any professional Editor, too, is unlikely to be unduly worried about the suggested loss of circulation. The few readers he loses will probably come back after an issue or two. It is the merit of a magazine that

in producing their two monthlies, and haven't got time to worry whether they are growing into vested interests or not.

R.S.G.B. Solidarity

The nature of the scarcely concealed attack on the Society certainly leaves doubt as to the intentions of the promoters of any rival organisation. If one were formed I can only imagine it would do some harm (according to its size) and no good to the well-being of the hobby. I cannot conceive it gaining any official recognition, and it is difficult to see what useful service it could perform which is not already adequately covered. One can therefore only assume that such an organisation would be formed to serve the interests of factional parties, and if this is so it would be foolish for amateurs to damage their own interests by supporting it.

It is no secret that there has been a difference between the Executive of the RSGB and a considerable section of its members. Unfortunately, there was an unavoidable delay before the account (genuinely objective) of it appeared in the Bulletin. There was, as a consequence, a certain amount of speculation and wild rumour. I received copies of all the circulars sent out by the dissentients. As a member, I admit to some sympathy with their views. The official attitude was not exactly conciliatory, but at every stage the dissentients behaved in a sensible manner. There was certainly no silly talk about resignations or the formation of a "rival" Society, and to my knowledge no move unconstitutional to the Society was even discussed by them.

It seems strange that a genuine desire for an alternative organisation by any large or responsible section of the amateur movement should, apparently, be made to the Editor of one radio journal only. Those

CENTRE TAP talks about

HOLIDAYS ABROAD — BITZAS — THE R.S.G.B.

increases the number of its readers; not the Editor's opinions. Taking sides in a controversial issue is quite as likely to swell the circulation as it is to diminish it, and those readers who enjoy the other contents are likely to stick.

Speaking of circulations reminds me that R.C.'s printing order is going up and up. The pleasure of reporting this, by the way, is not because my dividend might be increased. I have no financial interest in it. The Directors (all three of them!) are actively engaged

who are said to be agitating for a second National body are not only few in number, but seem to also lack responsibility. And it is not strange they should seek as their mouthpiece the same quarter from which similar "feelers" emanated as far back as January 1947?

Exaggeration

The R.S.G.B. is essentially a democratic body and is, in its major principles, truly representative of a world-wide movement. It has much good service to the hobby both

(contd. on page 239)

AN AUTO SCALE-SEARCHING LIGHT

By P. JOHNSTONE

THE device described in this article has been fitted to a home-built broadcast receiver by the writer for several months, and has proved very effective in use. Its purpose is to add extra illumination to the tuning dial whenever the tuning knob is rotated. In the particular receiver constructed by the writer, the dial is lit up all the time that the set is switched on, the degree of brightness being just a little more than sufficient to enable station names to be identified. Whenever the tuning knob is rotated, an extra set of dial lamps is switched on, these giving a much brighter dial and allowing tuning to be carried out more easily. When the required station has been found the extra lights still remain connected for a space of several seconds, after which they switch off automatically, the dimmer, more comfortable lighting once more being left in circuit.

The most important part of the device consists of a small automatic switch which is fitted to the tuning knob spindle. A simplified version of this switch is shown in Fig. 1. In this diagram a piece of springy metal strip, A, is mounted on the tuning spindle, B. A loose mechanical coupling exists by reason of the friction obtaining between the two; the amount of coupling

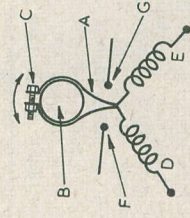

C536

Fig. 1. Simplified diagram showing the functions of the tuning spindle friction switch.

being adjusted by the screw, C. Two light springs, D and E, hold the metal strip central when the tuning spindle is at rest. Whenever the spindle is turned, the additional rotational force causes the metal strip to move also, thus making it touch either of the contacts F or G. When the spindle comes to rest again the springs pull the strip back to the central position.

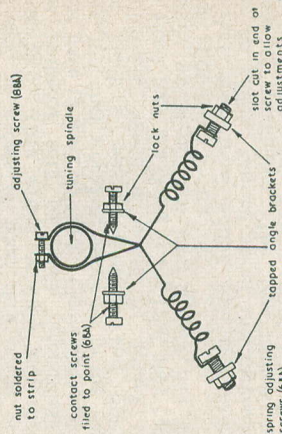

C537

Fig. 2. A suggested practical form of the switch.

This switch is not so delicate in action as it may at first sight appear. It is obvious, however, that it will work the more reliably when the slow-motion drive to the tuning capacitor has a reasonably high ratio, since the spindle is then turned more swiftly in order to tune in the receiver.

In practical form, the switch could be made in the form shown in Fig. 2. It will be seen that, in this figure, both the position of the contacts and the tension in the springs are made adjustable. The springy strip could conveniently be cut out from one of the brass terminals of an old 4.5 volt flash-lamp battery. To keep the strip in position it

might prove helpful to mount small bushes on the tuning spindle either side of it.

The electrical circuit controlled by the switch is very simple. Fig. 3 shows how the switch contacts cause a relay to close, which then switches on the additional dial lamps. The relay shown in the circuit is a high resistance model which obtains its coil energising voltage from the receiver HT. A low-voltage relay could, of course, be used in its stead provided that an appropriate source of DC was available. It will be seen that the tuning spindle itself provides the chassis connection for the circuit.

To show the extra dial lamp from switching off too quickly after the tuning spindle has come to rest it will probably be necessary to slightly adjust the relay. Most relays take an appreciable time to "fall off" after their energising current has been disconnected, this being due to the time taken for the induced magnetism to die away. This "fall-off" time may be utilised in this case to prevent the lights from switching off too soon and it can usually be increased by reducing the air-gap which exists between the armature and the core when the relay is energised.

Radio Miscellany--Contd.

at home and in Europe to its credit. The youthful amateur to-day has a lot to thank it for, and he should do everything in his power to strengthen its position. The Society represents his sheet-anchor in the maintenance of national goodwill, and may yet be his sole safeguard against possible future curtailment of his privileges by an autocratic officialdom.

It is unfortunate there is, in some quarters, a suspicion that views diverging from those of stronger elements in the Council are not given a reasonable hearing. That criticism, for whatever it is worth, is the only one

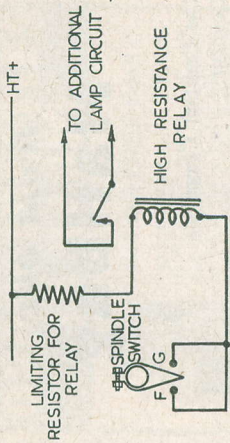

C538

Fig. 3. The switching and relay circuit.

In most relays this air-gap may be reduced by adjusting a small brass screw fitted to the armature or by judicious filing if the air-gap is fixed. The time of magnetic decay may be increased also by energising the relay with a higher voltage than that normally used.

In conclusion, it should be pointed out that this device can also be adapted for other functions, such as muting the receiver whilst tuning is in progress, and so on.

which might fairly be made. Any talk of fundamental disaffection is a gross exaggeration.

The best suggestion so far put forward (by a member of the Society) to scotch wild talk and at the same time satisfy the dissenters is to permit Council candidates to make Election Addresses through the columns of the Bulletin. This would silence the slurs one occasionally hears about the "old gang", and members would have the satisfaction of knowing they were voting for a policy; not simply for a name, which they may or may not have heard of before, and a short history of its association with the hobby.

ADCOLA
(Regd. Trade Mark)

SOLDERING INSTRUMENTS

Reg. Design No. 860302
(British, U.S. and Foreign Patents)

Designed for wireless assembly and maintenance. Supplied for all volt ranges from 67v to 230/250v. High Temperature, Quick Heating, Low Consumption, Light Weight.

3/16" Dia. Bit Standard Model 22/6
1/4" Dia. Bit Standard Model 25/0
3/16" Dia. Detachable Bit Type 30/0

Sole Manufacturers: **ADCOLA PRODUCTS LTD.**
General Offices and Works: Cranmer Court,
Clapham High St., London, S.W.4. (MAC 4272)

FRENCH IMPORTER

disposing numerous licences, wants all British or American made radio-electrical equipment from Surplus Stocks: Transmitters and Receivers, Measuring Instruments, Valves, sundry Spare Parts, etc. Send offers to: CIRQUE-RADIO 24 Boulevard des Filles-du-Calvaire PARIS XI^e Telephone VOLTAIRE 22-76 et 22-77.

from our Mailbag

The Constant Companion

Dear Sir,
I have built the Constant Companion Receiver to the words and music as published in your Radio Constructor; the only alteration was using a metal rectifier in place of the valve specified.

I am more than pleased with the results on the Medium waveband and have logged 8 stations besides the BBC. Transmissions very clear, with plenty of reaction using a 10-ft. whip aerial 6-ft. above ground.

My trouble is on the Long waveband. I can get practically no reaction and can only just hear the BBC's 1500 metre programme with everything turned right up. I have checked and double checked the tapping I made on the LW coil, and to all intents it seems OK. I have also checked the switch on the LW section and that seems in order.

I have tried bringing the aerial lead direct to the switch arm, which made no difference. I can get the station a little bit louder if I connect the aerial direct to the tag opposite to the red tag on the LW coil—this was purchased new 14 days ago.

The rest of the set must be OK or else I should not get such good results as I do on Medium waves.

What I am asking is, can any of your technicians, or the writer of the article, give me any idea as to any line I could take to improve the reception on Long waves?—G. J. Arthur, (Surbiton).

With reference to Mr. G. J. Arthur's letter:

At first sight, the lack of reaction on long-waves appears to be due to a fault on the coil. Nevertheless, as this has been thoroughly checked, we may assume that it is working correctly. An ohmmeter test of each winding should show a resistance of several ohms (if the meter is capable of reading as low as this) and not a dead short.

An aerial which has a high capacitance to earth may reduce the efficiency of the reaction circuit. Reaction should be checked with the aerial disconnected. If normal reaction then occurs a capacitor of some 100 pf can be connected in series with the aerial. Should a cure then result, the capacitor could be

permanently installed in the receiver between the appropriate wave-change switch contact and the aerial tap on the long-wave coil.

It is also possible that the long-wave coil is being dwarfed by the wiring and components in proximity to it. All such wiring should be moved away from the coil windings on the bobbin and positioned nearer the chassis or the top of the coil.

Reference to that part of the articles and the diagrams explaining the reaction circuit will show that one trimmer is used to set up the "standing" long-wave reaction and another to control the amount of capacitance inserted into the circuit by the reaction gang of the tuning capacitor. (Unfortunately, I cannot give circuit references as my files have not yet caught up with me; but it will be simple enough to identify these components). It is possible that long-wave reaction may be assisted by increasing the value of the first of these trimmers. The simplest way of doing this will consist of connecting an additional fixed capacitor across the trimmer, its value lying between 100 and 500 pf and being determined by experiment.

I feel confident that, unless an actual fault has occurred in construction, the above should supply the answer to Mr. Arthur's problem: and I would be very interested to hear from him again in the future and learn what results he may have obtained.

J. R. DAVIES.

Test Card 'C'

Dear Sir,

Your letter of November 5th to Mr. George Barnes, Director of Television, has been passed on to me, and I agree with you that at any rate three points of the answer you have printed on page 117 are indeed weak, namely, adjustment of salaries, additional use of Electricity and possible Trade Union activity. I have taken up these points with Mrs. Duffell and she assures me, however, that they were not given to you as part of our statement.

The facts are that at the moment we are unable to transmit Test Card 'C' each evening because of lack of apparatus for originating the Card at that time. The only available source is the Central Telecine Room which is at present engaged each evening on film line-up and rehearsal. We have some new equipment on order, however, which will provide an alternative source and when these 'monoscopes' (as they are called) are delivered the position will be reviewed again.

Yours faithfully,

BRIAN BEGG.

Television Publicity Officer.

OPPORTUNITIES IN RADIO

Get this FREE Book!

"ENGINEERING OPPORTUNITIES" reveals how you can become technically qualified at home for a highly paid key appointment in the vast Radio and Television industry. In 144 pages of intensely interesting matter it includes full details of our up-to-the-minute home-study courses in all branches of RADIO AND TELEVISION, A.M., Brit. I.R.E., City and Guilds, Special Television, Servicing, Sound-film Projection, Short Wave, High Frequency and General Wireless Courses.

We definitely guarantee "NO PASS — NO FEE"

If you are earning less than £14 a week this enlightening book is for you. Write for your copy to-day. It will be sent FREE and without obligation.

BRITISH INSTITUTE OF
ENGINEERING TECHNOLOGY

854, Shaftespear House,
17-19 Stratford Place,
London, W. 1.

BIET

Come to SMITH'S of EDGWARE ROAD the friendly shop for

We stock everything the constructor needs—our 25 years experience of handling radio parts and accessories enables us to select the best of the regular lines and the more useful items from the surplus market in.—

Loudspeakers and Phones Valves and CR Tubes
Transformers and Chokes Cabinets and Cases
Meters & Test Equipment Capacitors and Resistors
Pickups and Turntables Coils and Formers
Switches and Dials Aerials and Sockets
Metalwork and Bakelite Motors and Generators
Books and Tools Wires and Cables
Valve Holders and Cans Panel Lights and Fuses
Metal Rectifiers Recorders and Parts
Sleeving, Nuts and Bolts, Tags, Clips, Grommets and all other bits and pieces

NOTHING TOO LARGE—NOTHING TOO SMALL

Everything you need under one roof—including all the parts specified for the popular "Viewmaster" Home-built Televisor, both London and Birmingham models.

No general catalogue is issued owing to constantly varying stocks and prices; but we shall be pleased to quote you.

H. L. SMITH & CO. LTD.
287/9 Edgware Road, London, W.2

Telephone: Paddington 5891
Hours 9 till 6 (Thursday, 1 o'clock)
Near Edgware Road Stations, Metropolitan and Bakerloo

TV

TV

TELEVISION NEWS

keeps you in the TV picture

SEND FOR THE CURRENT ISSUE TODAY. USE THIS HANDY COUPON!

Regular features include
Free technical advice service • Summary of month's programmes in advance • New equipment and sets discussed • Latest books on TV reviewed • Authoritative articles on TV developments and techniques • Commentaries on past and future presentations • and many other important TV features.

TO THE CIRCULATION MANAGER
TELEVISION & GENERAL PRESS LIMITED
119 BRENT STREET LONDON N.W.4.

I enclose P.O. stamps value 1s. Send me the current issue of TELEVISION NEWS.

Name

Address

(Please use BLOCK CAPITALS)

If you must have a fit... fit an

OSMOR
'Q' COILPACK

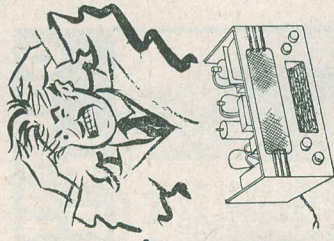

—for easy assembly and whistle-free reception. No complicated wiring circuits—just five simple connections for the OSMOR pre-aligned Coil-pack to be installed—and you're all set for receiving 'Loud' and 'Clear'. All types available for conversion of the Type 25 unit of the TRK.1196, also Type 18 and Wartime utility receivers, etc.

Send 5d. (stamps) for complete receiver circuit, also lists of Coils, Coilpacks and all Radio Components.

OSMOR RADIO PRODUCTS LTD. (Dept. R.C.5)
BRIDGE VIEW WORKS, BOROUGH HILL, CROYDON, SURREY. Telephone: Croydon 51487/9

PANEL TRANSFERS

Amateurs!

... Take Note

In response to the great number of demands for a further range of markings, we are now able to offer Range No. 2.

This sheet covers instruments:—Oscilloscope. Beam switch unit, A.F./R.F. Modulated Sig. Gen. Xtal and VFO freq. calibrating meter and sets of numerals to suit. Plus other useful markings.

This sheet, like sheet No. 1, is printed with silver lettering on a black background.

Price per sheet is 2/3d. post paid.

Still available is sheet No. 1. See our adverts in previous issues.

Order now and avoid disappointment.

Terms Cash with Order.

Details available on receipt of S.A.E. to—

K. NORVALL G3666
C/O, H. NORVALL & SONS LTD.,
5, Torrens Street, City Road, London, E.C.1.

Convert that old Gramophone into a MODERN all-WAVE RADIOGRAM or POWERFUL RECORD PLAYER

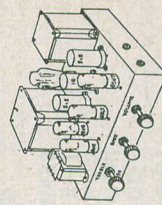
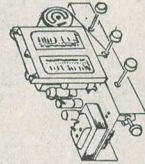

Our "Skyway"

26

DESIGNS" Book gives full details on how to build FOUR first-class Amplifiers and Radiogram sets. Includes the clear circuit diagrams and stage by stage wiring plans.

All parts and materials are easily obtainable, mostly without purchase tax. Performance equal to radiograms costing over £100

only from **Smith RADIOCRAFT Ltd**
69-71 CHURCH GATE, LEICESTER
PHONE 58977

—The—
World Radio Valve Handbook

Edited and published by O. Lund-Johansen of World Radio Handbook fame, this publication gives details, characteristics and comparison data of most of the normally used valves in the world. A most comprehensive reference book.

Available Now.
price 11/6.

Trade Enquiries Invited

Amalgamated Short Wave Press, Ltd.
57, Maida Vale, Paddington, W.9

"YOU CAN RELY ON US"

BRIMAR OSRAM MULLARD Valve Manuals 5/- each

SELENIUM RECTIFIERS

EH 24/6 New Westinghouse—36EHT 100-27/10, 14A86-1813, 14D36-11/-, WX3-3-7, WX3-3-7, Instrument 1m/A Rect. 11/4, 12v 5mA 1/2 wave-1/-, LINE CORD 3 WAY 0.2amp 100Ω per foot—8d. Ft. 0.3amp 60Ω per foot—8d. Ft.

DROPPERS

Standard 0.3A 800Ω 5/-, 0.2A 950Ω 5/-, Midget 6/3 each 2 1/2 high.

SURPLUS VALVES

Here are a few—write for our "Valve Bargain List" with over 120 types. 6AG5-9/6, EF50-7/6, 6H6m-4/6, 12A6m-8/1-, 3A4-7/6, 6K6g-8/6, 3Q5-8/6, 6J5g-6/6, 6SH7 metal-7/6, 6BW6-12/6, 6BE6-15/1-, 6AT6-10/6, 6BA6-12/6, 6OC5-13/6.

TUBULAR CONDENSERS

0.001, 0.002, 0.004, 0.005, 0.01, 0.1 6d. each. 0.25μF, 1/- each. 0.5μF, 1/6 each.

MICA CONDENSERS

0.0001, 0.0007, 0.0003, 0.0005, 0.001, 0.002, 0.005 6d. each.

VALVE CANS

3 piece aluminium, (Octal valves) 1/6 each.

TRIMMERS

30pF 50pF-9d., 100pF 150pF-1/-, 250pF-1/7-, 500pF-2/-, 750pF-2/3.

And we sell the "Radio Constructor". Write for our 32 page catalogue No. 10 Price 6d.

RADIO SERVICING COMPANY (Dept.K)
444, WANDSWORTH ROAD, LONDON, MACaulay 4155-S.W.8.

VALVES.

VU111-6KV EHT. Rect. 6/6; VU133-J.S.K.V. 5/-; ML.4 6/-; 6C6-6D6, 7/6; KTZ63-617 7/6; 6F7, 7/6; EL3, 10/-; EL50 7/6; 12Q7 9/-; 12K8 11/-; 12SR7-12SQ7 9/-; PEN46 TV-line-output 7/6; 12S17 7/-; Y63 6.3, Magic eye 8/6; EF50 New 7/6; EBC33 6/6; EF36 6/6; EF22 7/6; SP41 3/6; VP4B 7/6; 6K7, 6/6; SY3 10/-; SZ4 9/-; 2X2, 4/-; PH2 Bart. Output, 5/-; 6S57, 6/6; 6S77, 7/6; (832 Fil. tested only. No Guarantees given on 832 valves) 15/- 6X5, 8/-; 807, 11/-; TZ40, £1 0 0; 6AC7, 6/6; SP61, 3/6; 110 volt AC Midget Motors, 12/6; 70 mA Ported U.S.A. midget chokes, 5/-.

RECEIVERS.

Battery Superhet chassis, Medium Wave, complete, £2 0 0. Ex-NAAF! Rees Place Superhet Chassis, Medium, Short and Long Wave, complete with all valves and 8 inch PM Speaker. My price—£7 10 0. These receivers, in tip top condition, are an excellent bargain—call and see them.

WANTED

ALL TYPES OF RADIO-ELECTRIC-AL EQUIPMENT. Receiving and Transmitting gear; Test Equipment and Electrical Motors etc., etc.

Please call or phone.

THE CHEAPEST RADIO SHOP

"In Town"

SOLIDAS LTD.

4 PRAED STREET, W.2. Tel: AMB 4670
JUST OFF EDGWARE ROAD

BC 950 100-144 MC Transmitter Less Valves 17/6; Canadian MK. 58 Trans-Receiver £12 complete, B 36 £10.

POSTAGE EXTRA ON ALL ORDERS.

Slow Motion Drive with 1 1/2" drum attached 2/-; 4-way Push Button unit with buttons and plate 2/6; 40 ohm Moving Coil Mike 5/-; Medium and Long Wave TRF Coils 5/- pair; Midget SHET Coil Pack; short and medium waves 8/6; U.S.A. type Push-Pull output trans. O.K. for 61.6-KT66. £1 0 0; 150 MA, 350-0-350-6.3 5V. Trans. £1 0 0; Mains interference suppressor, 7/6, very effective 10,000 ohm. relay 6/-; 20 A.H. Glass Accumulator 4/6; 24 volt small motor AC-DC Double Spindle 8/6; 230 volt motor AC-DC with 3 speed gearbox. 19/6; Volt-meter 30-0-30-30-3-0-3V. DC., 10/- with test lead.

SMALL ADVERTISEMENTS

Readers' small advertisements will be accepted at 2d. per word, minimum charge 2/-. Trade advertisements will be accepted at 6d. per word, minimum charge 6/-. If a box number is required, an additional charge of 1/- will be made. Terms: Cash with order. All copy must be in hand by the 12th of the month for insertion in the following month's issue.

TRADE

E. M. I.

JOB OR HOBBY—Whichever it is in Radio or Television, we can help you. Backed by the great E.M.I. organisation, we can offer the most authoritative and up-to-the-minute Home Study courses in Radio, Television and Electronics. **FREE BROCHURE** from E.M.I. INSTITUTES, Postal Tuition Division, Dept. R.C.11, 43, Grove Park Road, Chiswick, London, W.4, Chiswick 4417.

QRP. A monthly duplicated production, edited and produced by J. Whitehead for those interested or engaged in QRP work. Twenty pages plus cover, it costs but 8/- per annum, post free. Covering the whole field of low power radio, it is a must for every QRP enthusiast. The **ONLY** magazine devoted entirely to low power working. Order from—J. Whitehead, 6, Abbot's Tilt, Hershham, Walton-on-Thames, Surrey.

JOIN THE ISWL. Over twenty free services to members including OSI, Bureau, Translation, Technical and Identification departments. Dx certificates and activities for the SWL together with over seventy local Groups in this country. Monthly magazine "MONITOR", first issue out in January, twenty pages plus cover, duplicated, containing articles of general interest to the SWL and League member. 8/- per annum post free. ISWL HQ, 123, Sturlia Road, Chatham, Kent.

"PANEL"—the air drying black crackle finish. Applied like ordinary paint. Details from L. Miller, 8, Kenton Park Crescent, Kenton, Middlesex.

BLUEPRINTS. SWN short wave One-Valve, battery driven using DF91 valve. 1s. 8d. post free, complete with instructions. High Gain 10 Metre Converter, with a deluxe circuit comprising EF91 RF stage, ECC91 double triode mixer and oscillator, EF92 IF amplifier with stabilised voltage supply via a 7475. 1s. 8d. post free with full instructions.

REPRINT. Converting The TR1196 Receiver. Full details on converting this unit, which may be purchased quite cheaply, into a very sensitive all-wave receiver, 6d. post free. All the above from A.S.W.P., 57, Maida Vale, London, W.9.

"GLOBE-KING" (Regd) Miniature Single Valve Receiver gets real DX—Amateur Radio enthusiasts should send for free copy of interesting literature and catalogue (enclose stamp for postage). Write to makers: Johnsons (Radio), 46 Friar Street, Worcester.

BOOKBINDING. Volumes of Radio Constructor and Short Wave News fully bound, imitation leather, gold lettering. 7s. 6d. post free. Prices for other publications on application.—Jerome Alcock, CHEADLE, Stoke-on-Trent.

TV COILS, ALL TYPES—Bel Sound Products Co., Marborough Yard, London, N.19. ARC. 5078.

PRIVATE

CR100 as new. 60 Kcs-30 Mcs. Crystal, BFO etc. £28. Seen working. Jones, 10 Schubert Road, London, S.W.15.

FOR SALE. Home built cabinet for Premier Telesistor. Magnifying lens. Mask. Also VCR97 little used. Corsor 6" electrostatic tube type 3244 (K), white trace, used, good working condition. £4-10-0 the lot. COD. Gregory, 24 Caversham Road, Reading, Berks.

R1082 RECEIVER. Complete with case of plug in coils. Good condition £2. Also Avomixer in leather case £1-10-0. BCM/RADIVIS, London, W.C.1.

FOR SALE. Signal Generator, 100 Kcs-130 Mcs. Universal Valve Tester. B.P.L. Super Ranger. B.P.L. Universal Bridge. 2 1/2" Oscilloscope, 10-50K c.p.s. Any inspection. Also Wee Megger, faulty. Genuine Bargains, £36. Bond, 49a North Street, Coventry.

FOR SALE. Hallicrafter S-40A 9-tube receiver. 540 kc to 43 mcs. Perfect condition. One professional owner only. Offers considered above £25. Sherratt, 82 High Street, Newport, Isle of Wight. Phone 2504. G5TZ.

FOR SALE. Avo valve tester only slightly used £12. Also Avo All Wave Oscillator in perfect working order £8-10-0. Westby, 21 Eastville Avenue, Rhyl, Flint, Wales.

VIEWMASTER completed to stage 5, for sale £10. Original cost £18. Crisp, 138 Coldershaw Road, W. Ealing, London.

URGENTLY REQUIRED. Instruction Manual S640. State price. Saunders, 86 Gwydir Street, Cambridge.

WANTED. Communications receiver preferably BC342, 348 or 1155N, for AC mains with speaker output (about £12). Robinson, 21 Lower Morden Lane, Morden Park, Surrey.

WANTED. R1116 in exchange for R1082 (complete with coils). G3INT, Vinnycote, Milesplit Hill, London, NW7.

SUCCESS?

In Radio, Television and Electronics, there are many more top jobs than engineers qualified to fill them. Because we are part of the great E.M.I. Group we have first-hand knowledge of the needs of employers, thus our Home Study courses are authoritative and based upon modern industrial needs.

POST THIS COUPON NOW **START HERE**
E.M.I. INSTITUTES, Postal Division, Dept. 179
43 GROVE PARK RD., CHISWICK, LONDON, W.4
Please send, without obligation, your **FREE BROCHURE**
I have marked the subjects which interest me.

Mechanical Eng. Electrical Eng. Draughtsmanship. Radio. Television. Production Eng. Automobile Eng. Aeronautical Eng. General Cert. of Education (Materie). Civil Service.

Also Courses for—
A.F.R.A.S. CITY and GUILDS EXAMS in Mech. Eng., Elect. Eng., Telecommunications, etc.

NAME.....
ADDRESS.....

E.M.I. INSTITUTES—The College backed by an industry

NORMAN H. FIELD

Mail Order Dept. WOLVERHAMPTON, 5
64-65, CHURCH LANE, WOLVERHAMPTON.

AT 12/6: 6SN7, 6K9, 6X1, 6Q7, 6T61, KT63, KT66, ECC82, 5Y3, 5Z4, 6AL Brand new Bulvac. At 9/-: 125C7, 127A, PEN46, 125T, 30V, GBC. At 9/-: 4F5, 807, APR3, 124, 1S1, 1B5, 1S5. At 7/6: VR52, EL37, EBC33, VR55, 767, 77, VR19, 617, VR153, 664, TP2, 15 G5, 7C7, VR169, 617/G, YCS, ASP72, TP2, 15 G5, 1246, 12AC7, AT 7/6: 6B8, 6B8G, 6G6, 6G7, C, 6K7, G, 11H4, VR33, EF9, EF36, 135, 0/6, APR157, VP56, VT224, RK37, 2C3, AR8, HL30, AR12, 6C3, 6T, 617, 6537, 617/G, 687/G, VR9, EF50, 31D6, 65K7, TT11, VT501, PEN2, 5, 6S, 125K7, 2A3, VU133, 2V3G, 1623, VT501, PEN2, 5, V, 118, KT2. At 4/6: 615/G, 615/G, 15SH7, 12H6, UJ10. At 3/6: RKR72, ARP3, 9D2, 615, AR3, VR18, 2155G, 2X2, UJ11, HLZ. VR2, VR66, P61, 665, SP61, VR65A, SP41, AC 216: VR34, EB34, VR92, EA50, VR78, DI. At 1/9: 7193.

All boxed, Tested and Guaranteed.
TOM GAMBLE (G3DBL) asks VIEWMASTER CONSTRUCTORS to call and SAVE MONEY by Building his way.

EHT TRANSFORMERS 2,500 V 5 M/A 4V 2 Amp. 0.2-4. 4 Imps 210—250 V 50 Cycles Completely Wax Impregnated GUARANTEED 41/9.

SWITCHES YAXLEY NEW 4 Pole 2 Way 3 Bank 3/4-3 Pole 3 Way 3 Banks 3/6.

NIFE Accumulators 2.5 V 15 A/H Metal cased 7/-; CHOKES 60 Ohms 200 M/A 3 1/2" x 3 1/2" x 2" Suitable Viewmaster, 4/-; 1155 D.F. LOOP Aerials 8/6; CRYSTALS 500 Kcs. 7/-; BELLING LEE Plugs and Sockets 5 pin New Pair 2/3.

Please include something for Postage. Money Back Guarantee.

Building a Telesvisor?

THEN CONSIDER THE FOLLOWING

RECEIVER R.1355, as specified for "Inexpensive Television", Complete with 8 valves VR65 and 1 each 5U4G, VU120, VR92, also a copy of "Inexpensive TV", ONLY 55/- (carriage, etc., 7/6). Copy of book only 2/6

I.F. STRIP 194. Another of the units specified as an alternative for the "Inexpensive TV". A first-class strip giving tremendous amplification, and well recommended for constructors who have built telesvisors but have come "unstuck", in the vision or sound-receiver. Complete with 6 valves VR65, and 1 each VR33 and VR92, and a copy of the book, which gives full details of conversion to both stations. Size 18in. x 5in. x 5in. ONLY 45/- (postage, 2/6).

"PYE" 45 mc/s. I.F. STRIP. Ready made for London vision channel. Complete with 6 valves EF50 and 1 EA50. ONLY 60/- (postage, etc., 4/6).

RECEIVER R.3547. This contains the "PYE" strip, which can be easily removed if desired, and also 15 valves EF50, 3 of EB34, 2 of SP61, and 1 each EA50, EBC33, EF36, also hundreds of resistors, condensers, etc. BRAND NEW "IN MAKERS' CASES. ONLY 120/- (carriage 7/6).

Cash with order, please, and print name and address clearly.

U.E.I. CORPORATION,

The Radio Corner, 138, Gray's Inn Road, London, W.C.1. (Phone TERMINUS 7937)
Open until 1 p.m. Saturdays. We are 2 mins. from High Holborn. 5 mins. by bus from King's Cross.

CLYDESDALE

Bargains in Ex-Services Equipment.

W 5.18 RECEIVER SECTION. Superhet chassis, range 6—9mcs (50—33.3 metres) with 4 valves 3JARP-12, AR8, etc., etc. POST PRICE ONLY. Circuit 2/3d.

Also available with partly stripped (MOS) Tx. section no valves, or meter, in metal carrying case. Dim. 11 x 10 x 17 ins. CARRIAGE PRICE ONLY. Circuit for 4/6d.

COMMAND RECEIVER CCT/CBY46129. BC-453 for that Sharp channel "Q-Fiver", range 550-190 Kcs. with 6 valves. Dim.—11 x 5 1/2 x 5 ins. finish black, less dynamotor. CLYDESDALE'S PRICE ONLY. 70/-

Circuits of BC-453 available at 1/3d. **TRANSMITTER TUNING UNITS**. Unused, but externally soiled, cases slightly dented and scratched, dim. 1 1/2 x 7 1/2 x 8 ins. approx. T.U.58, T.U.59, T.U.68, T.U.78, T.U.88, T.U.9B, T.U.26B. 35/6d. ea. 1st grade at 22/6d. ea.

NEW LIST NO. 8. Now Ready—1/6d. Price credited on first purchase of 10/0d. or over.

Order direct from: Tel.: SOUTH 2706/9
CLYDESDALE SUPPLY CO. LTD.
2 BRIDGE STREET, GLASGOW, C.S.
Branches in Scotland, England and North Ireland.